



## THE INDUSTRY STANDARD

The Tommy Gate G2 Series is a dual-cylinder, parallel-arm design which utilizes a pair of hydraulic cylinders to lower and raise the lift by applying direct power to both sides of the platform. G2 Series liftgates for pickups are versatile, popular, and modern.

### G2-60-1542 EA38

*Shown with optional rubber platform bumpers and discontinued recessed light kit. Recessed lights have been replaced by a bolt-on kit.*

Frames and platforms on every G2 Series liftgate are hand assembled and hand welded, while precision parts are laser cut and/or robotically welded.



## DUAL-DRIVE ADVANTAGES

Dual-drive liftgates provide increased durability for rigorous cycling and have low maintenance requirements. A paint-before-assembly process also increases the longevity of the lift's aesthetics.

## G2 SERIES LIFTGATE FEATURES

- Dual hydraulic cylinders
- Virtually maintenance-free components
- Recessed control
- Larger platforms
- Fully-enclosed hydraulic system located within the lift mainframe



**AVAILABLE MODELS**

TWO-YEAR STANDARD WARRANTY

	Model Number	Load Area	Taper	Travel	Platform Fold	Application <sup>1</sup>	Gate Weight
<b>1300 lb. Capacity</b>	Treadplate Platforms						
	<b>G2-60-1342 TP27</b>	55 x 27	4	42	No	A,B	438
	<b>G2-60-1342 TP38</b>	55 x 38	4	42	Yes	A,B	478
	<b>G2-60-1342 TP42</b>	55 x 42	7	42	Yes	A,B	503
	TommyTraction™ Platform						
	<b>G2-60-1342 TT27</b>	55 x 27	4	42	No	A,B	439
	Aluminum Platforms						
	<b>G2-60-1342 EA27</b>	55 x 27	6	42	No	A,B	395
	<b>G2-60-1342 EA38</b>	55 x 38	6	42	Yes	A,B	421
	<b>G2-60-1342 EA48 <sup>2</sup></b>	55 x 48	6	42	Yes	A,B	442
Bar Grate Platform							
<b>G2-60-1342 BG27</b>	55 x 27	4	42	No	A,B	445	

<b>1500 lb. Capacity</b>	Treadplate Platforms						
	<b>G2-60-1542 TP27</b>	55 x 27	4	42	No	B	438
	<b>G2-60-1542 TP38</b>	55 x 38	4	42	Yes	B	478
	<b>G2-60-1542 TP42</b>	55 x 42	7	42	Yes	B	503
	TommyTraction™ Platform						
	<b>G2-60-1542 TT27</b>	55 x 27	4	42	No	B	439
	Aluminum Platforms						
	<b>G2-60-1542 EA27</b>	55 x 27	6	42	No	B	395
	<b>G2-60-1542 EA38</b>	55 x 38	6	42	Yes	B	421
	<b>G2-60-1542 EA48 <sup>2</sup></b>	55 x 48	6	42	Yes	B	442
Bar Grate Platform							
<b>G2-60-1542 BG27</b>	55 x 27	4	42	No	B	445	

**G2 MODELS FOR MID-SIZED PICKUPS**





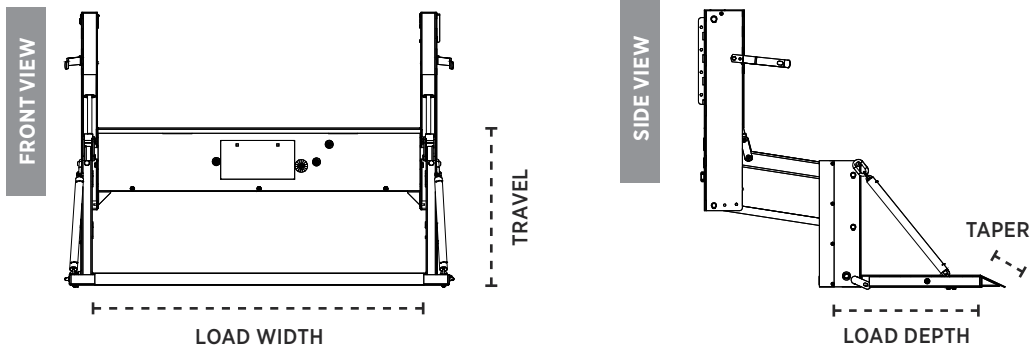

<b>750 lb. Capacity</b>	Treadplate Platforms						
	<b>G2-54-7542 TP38</b>	49 x 38	4	42	Yes	G	421
	Aluminum Platforms						
<b>G2-54-7542 EA38</b>	50 x 38	6	42	Yes	G	369	

**G2 SERIES DIMENSIONS <sup>3</sup>**









1. See applications on page 51.
2. EA48 platform extends 10" above top of liftgate mainframe. See image on page 13.
3. For detailed dimensions, visit [www.tommygate.com](http://www.tommygate.com)



STANDARD FEATURES



	Fixed and Timed Toggle Control
	Recessed Control
	Vehicle-specific Mounting Brackets
	Power Cable with Full-length Ground
	150-amp Circuit Breaker
	Maintenance-free Pins and Bushings
	Drop-away Platform
	Hitch Compatible <sup>1</sup>

AVAILABLE OPTIONS

	Remote Pendant Control
	Dual Controls
	Rubber Platform Bumpers
	Bolt-on, 3-Light, LED Light Kit
	Bolt-on, 2-Light, LED Light Kit
	Galvanized Frame and Platform <sup>3</sup>
	Rear Camera and Sensor Bar
	Folding Tire Rack <sup>2</sup>

1. Compatible with many hitches. Visit [www.tommygate.com](http://www.tommygate.com) to view complete hitch chart.
2. Not compatible with folding platforms. See spec charts.
3. Galvanized option not available with Steel Treadplate platforms. Call factory for ordering details.

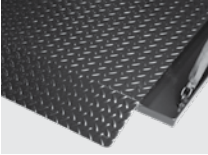
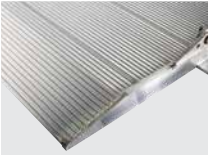
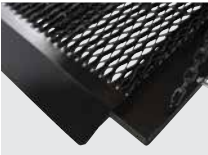
**PLATFORM MATERIALS**

	Steel Treadplate
	Extruded Aluminum
	TommyTraction
	Steel Bargrate

**GALVANIZING OPTION**

A high-quality galvanized finish supports long-lasting performance and appearance in even the most extreme climate conditions.

*Not available with Steel Treadplate platforms.  
Call factory for ordering details.*



**STEEL PLATFORMS**

**TP27 - 27" Loading Depth**

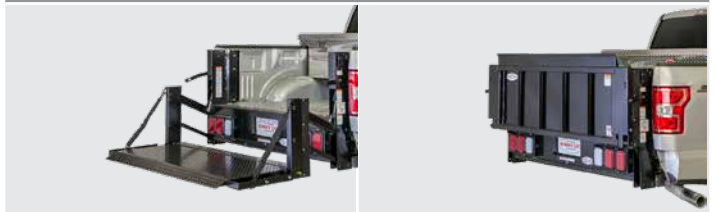

**TP38 - 38" Loading Depth**



**TP42 - 42" Loading Depth**

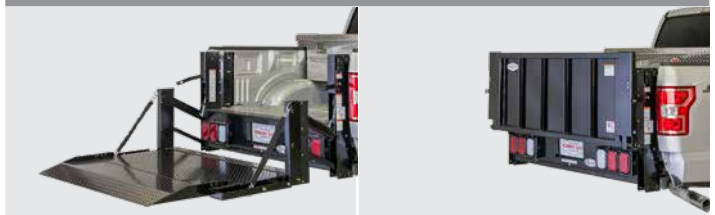

**ALUMINUM PLATFORMS**

**EA27 - 27" Loading Depth**



**EA38 - 38" Loading Depth**



**EA48 - 48" Loading Depth (EXTENDS ABOVE TRUCK BOX)**

