



# TRUCK TOOL BOXES



**ALL NEW**  
**CAM LOCK BOXES**  
*See pg. 26*

**PLUS NEW**  
**Tunnel Boxes**  
*See pg. 68*

**NOTHING WORKS LIKE A DOGG™**

# Our History



**1946**  
Buyers Products Company founded by Sam Ruven and Bessie Kleinman as a distributor of driveline components.

**Tacom**

**1992** Buyers acquired Trailer Components Manufacturing (Tacom) for CNC precision machining and tooling, as well as state-of-the-art welding.

**Buyers**

Buyers continued to grow its product offerings and build valued relationships with customers and suppliers. Increased demand for products led to the pursuit of supply chain manufacturing solutions.

**PROGRESSIVE**  
POWDER COATING, INC.

**1995** Buyers acquired Progressive Powder Coating. Our Nordson automatic powder application booth is used to powder coat our Buyers toolboxes and other truck and trailer accessories.

**Buyers**

**2002** Buyers moved its corporate headquarters to a brand new 235,000 sq. ft. state-of-the-art office and distribution center.

**Romotech**  
ROTATIONAL MOLDING TECHNOLOGIES, INC.

**2004** Buyers acquired Romotech in New Paris, Indiana. Our Ferry Industries Rotospeed molding machines are used to manufacture our poly salt spreaders.

**SnowDogg**  
Buyers

**2007** Buyers began manufacturing the SnowDogg stainless steel snowplow at our Mentor, Ohio facility.

**Boomerang**  
RUBBER, INC.

**2009** Buyers began our operations at Boomerang Rubber, in Botkins, Ohio manufacturing mudflaps, wheel chocks and other rubber truck and trailer accessories.

**Buyers**

**2013** Buyers acquired an additional 500,000 sq. ft. manufacturing facility in Mentor, Ohio allowing for expansion of our aluminum and stainless steel manufacturing.

**SaltDogg**  
Buyers

**Buyers**

**2016** Buyers establishes a 22,000 sq ft Engineering Tech Center in Mentor, Ohio. It's multi-use lab, design, training and prototyping space is dedicated to the research and development of innovative product.

**ALL YOUR WORK  
TRUCK PRODUCTS  
ALL THE TIME.**

**2017** Buyers launches new website with business partner portal, to make online ordering and account maintenance easy for customers.

**Buyers**

**2021** Buyers adds almost 300,000 sq ft of additional, state-of-the-art warehouse and office space to maintain the quick turnaround and competitive value their customers expect.

## Our Corporate Family of Companies



Founded in 1946, Buyers Products is a fully integrated manufacturer and a leader in the truck equipment industry. Our engineering, manufacturing and assembly operations take place in the USA, under the Buyers family of companies. **Buyers Products' mission is to improve our Customers' profitability and productivity while enhancing the quality of our products and services.**





**UNDERBODY ..... 4-37**

- PRO Series Steel..... 6-9
- Steel ..... 10-19
- PRO Series Aluminum..... 20-25
- Cam Box Aluminum ..... 26-27
- Aluminum ..... 28-32
- Polymer ..... 33
- Mounting Brackets..... 34-35

**TOPSIDER ..... 36-45**

- PRO Series Steel..... 38
- Steel ..... 39
- Aluminum ..... 40-45

**BACKPACK ..... 46-67**

- Four Door Offset, Aluminum ..... 48-49
- Four Door Offset, Steel ..... 50-51
- Four Door Flat, Aluminum ..... 52-53
- Four Door Flat, Steel ..... 54-55
- Two Door Offset..... 56-57
- Two Door Flat..... 58-59
- L-Pack..... 60-61
- Underbody Boxes ..... 62-63
- Accessories..... 64-67

**TUNNEL BOXES ..... 68-71**

**IN-BED STORAGE..... 72-85**

- Crossover ..... 74-75
- Gull Wing..... 76-77
- Lo-Sider..... 78-79
- Storage Chests ..... 80-85

**TRAILER TONGUE ..... 86-87**

**CLASS 8 BOXES ..... 88-91**

**PARTS & ACCESSORIES ..... 92-94**

**DISPLAYS..... 95**

**REPLACEMENT PARTS..... 96-97**

**INDEX ..... 98-99**

**PRODUCT HIGHLIGHTS:**

**NEW TUNNEL BOXES**

*pg. 68*



**COMPLETELY REDESIGNED GULL WING SERIES**

*pg. 76*



**NEW ALUMINUM UNDERBODY with CAM LOCK HARDWARE**

*pg. 26*





# UNDE



# UNDERBODY

# PRO SERIES STEEL TRUCK TOOL BOXES

# MAXIMUM DURABILITY MAXIMUM PROTECTION



1752805  
18x18x36 Drop Down

## PRO SERIES DURABILITY

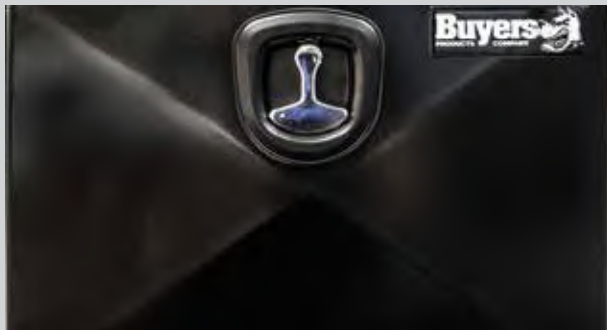

12 Gauge steel with cross break in door for added strength

## PRO SERIES PROTECTION



Rain gutter with automotive bulb seal keeps gear dry

## PRO SERIES SECURITY



Maximum door security with heavy duty 3/16" door chains

## PRO SERIES RELIABILITY



Corrosion resistant stainless steel bolt-on hinge

# ALL THE FEATURES A *PRO* WOULD DEMAND

## PRO SERIES UNDERBODY



VS

## STANDARD UNDERBODY



**Maximum Material Thickness** 12 Gauge Steel

**Maximum Weather Protection** Rain Gutter with Automotive Bulb Seal

**Maximum Door Security** 3/16" Door Chains

**Hinge** Stainless Steel Bolt-On Hinge with a 1/4" Pin

**Door** Offset Door

**Material Thickness** 14 Gauge Steel

**Weather Protection** Weather Resistant Seal

**Door Security** Steel Wire Lanyards with PVC Coating

**Hinge** Stainless Steel Bolt-On Hinge

**Door** Recessed Door

# PRO Series Steel Underbody

- 12 gauge steel box and cross-broke door
- Removable door design
- Automotive D-bulb seal
- Stainless steel bolt-on continuous hinge with oversized 1/4" pin
- Built-in rain gutter
- Detachable 3/16" door chains
- Locking die cast T-handle compression latch

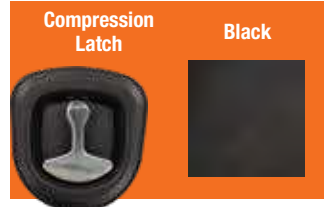

## Black, Single Latch



| Part No. | Height | Depth | Width | # Latches per Door | Wt. (lb) | Cat.    |
|----------|--------|-------|-------|--------------------|----------|---------|
| 1752800  | 18     | 18    | 24    | 1                  | 80       | 530 (Y) |
| 1752803  | 18     | 18    | 30    | 1                  | 91       | 530 (Y) |
| 1752805  | 18     | 18    | 36    | 1                  | 104      | 530 (Y) |
| 1752810  | 18     | 18    | 48    | 1                  | 127      | 530 (Y) |
| 1754800  | 24     | 24    | 24    | 1                  | 90       | 530 (Y) |
| 1754803  | 24     | 24    | 30    | 1                  | 115      | 530 (Y) |
| 1754805  | 24     | 24    | 36    | 1                  | 132      | 530 (Y) |

## Black, Double Door

*Works great as Topsider on flatbeds and service bodies.*



| Part No. | Height | Depth | Width | # Latches per Door | Wt. (lb) | Cat.    |
|----------|--------|-------|-------|--------------------|----------|---------|
| 1752815† | 18     | 18    | 60    | 1                  | 175      | 530 (Y) |
| 1752825† | 18     | 18    | 72    | 1                  | 202      | 530 (Y) |
| 1752835† | 18     | 18    | 90    | 1                  | 228      | 530 (Y) |
| 1752836† | 18     | 18    | 96    | 1                  | 250      | 530 (Y) |

†Boxes can be used as topsiders and underbodies





See pg. 34-35 for Underbody Mounting Brackets

# Steel Underbodies



## Steel Features



Bolt-on, stainless steel continuous hidden hinge

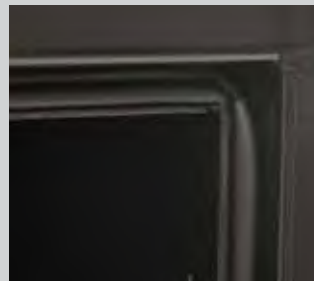

Replaceable gasket sealing system

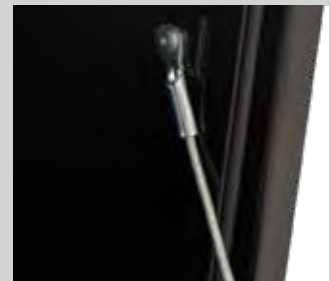

Aircraft grade door cables

## T-HANDLE LATCH

- 14 gauge powder-coated steel box with 12 gauge steel door
- Drop-down recessed door
- Locking stainless steel T-handle latches
- Bolt-on, stainless steel continuous hidden hinge
- Replaceable gasket sealing system
- Aircraft grade door cables
- Reinforced door backbone on boxes 48" and wider
- Door opening: flat surface mount (90°) or underbody mount (180°)

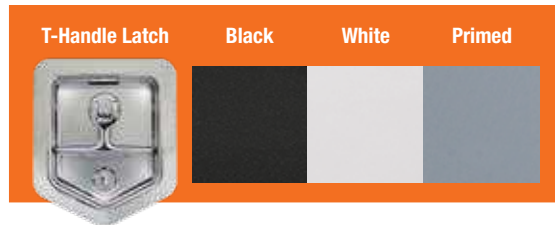

### Black, Single Latch



| Part No. | Height | Depth | Width | # Latches per Door | Wt. (lb) | Cat.    |
|----------|--------|-------|-------|--------------------|----------|---------|
| 1703349  | 14     | 12    | 18    | 1                  | 37       | 530 (Y) |
| 1703350  | 14     | 12    | 24    | 1                  | 40       | 530 (Y) |
| 1703353  | 14     | 12    | 30    | 1                  | 49       | 530 (Y) |
| 1703300  | 14     | 16    | 24    | 1                  | 56       | 530 (Y) |
| 1703303  | 14     | 16    | 30    | 1                  | 65       | 530 (Y) |
| 1703305  | 14     | 16    | 36    | 1                  | 74       | 530 (Y) |
| 1703310  | 15     | 10    | 15    | 1                  | 28       | 530 (Y) |
| 1703312  | 15     | 10    | 24    | 1                  | 39       | 530 (Y) |
| 1703320  | 15     | 13    | 15    | 1                  | 32       | 530 (Y) |
| 1703322  | 15     | 13    | 24    | 1                  | 45       | 530 (Y) |
| 1703324  | 15     | 13    | 30    | 1                  | 53       | 530 (Y) |
| 1703326  | 15     | 13    | 36    | 1                  | 61       | 530 (Y) |
| 1703330  | 16     | 14    | 18    | 1                  | 50       | 530 (Y) |
| 1702295  | 18     | 18    | 18    | 1                  | 47       | 530 (Y) |
| 1702300  | 18     | 18    | 24    | 1                  | 67       | 530 (Y) |
| 1702303  | 18     | 18    | 30    | 1                  | 80       | 530 (Y) |
| 1702305  | 18     | 18    | 36    | 1                  | 92       | 530 (Y) |
| 1704300  | 24     | 24    | 24    | 1                  | 87       | 530 (Y) |
| 1704303  | 24     | 24    | 30    | 1                  | 100      | 530 (Y) |
| 1704305  | 24     | 24    | 36    | 1                  | 116      | 530 (Y) |

### Black, Dual Latch



| Part No. | Height | Depth | Width | # Latches per Door | Wt. (lb) | Cat.    |
|----------|--------|-------|-------|--------------------|----------|---------|
| 1703328  | 15     | 13    | 48    | 2                  | 83       | 530 (Y) |
| 1702310  | 18     | 18    | 48    | 2                  | 118      | 530 (Y) |
| 1702315  | 18     | 18    | 60    | 2                  | 143      | 530 (Y) |
| 1702317  | 18     | 18    | 66    | 2                  | 186      | 530 (Y) |
| 1708310  | 18     | 24    | 48    | 2                  | 133      | 530 (Y) |
| 1704310  | 24     | 24    | 48    | 2                  | 145      | 530 (Y) |
| 1704315  | 24     | 24    | 60    | 2                  | 175      | 530 (Y) |

### Black, Double Door



| Part No. | Height | Depth | Width | # Latches per Door | Wt. (lb) | Cat.    |
|----------|--------|-------|-------|--------------------|----------|---------|
| 1702325† | 18     | 18    | 72    | 1                  | 156      | 530 (Y) |

†Boxes can be used as topsiders and underbodies

# Steel Underbody

## White, Single Latch



| Part No.       | Height | Depth | Width | # Latches per Door | Wt. (lb) | Cat.    |
|----------------|--------|-------|-------|--------------------|----------|---------|
| <b>1703400</b> | 14     | 16    | 24    | 1                  | 56       | 530 (Y) |
| <b>1703403</b> | 14     | 16    | 30    | 1                  | 65       | 530 (Y) |
| <b>1703405</b> | 14     | 16    | 36    | 1                  | 71       | 530 (Y) |
| <b>1703495</b> | 18     | 18    | 18    | 1                  | 47       | 530 (Y) |
| <b>1702400</b> | 18     | 18    | 24    | 1                  | 67       | 530 (Y) |
| <b>1702403</b> | 18     | 18    | 30    | 1                  | 80       | 530 (Y) |
| <b>1702405</b> | 18     | 18    | 36    | 1                  | 92       | 530 (Y) |
| <b>1704400</b> | 24     | 24    | 24    | 1                  | 87       | 530 (Y) |
| <b>1704403</b> | 24     | 24    | 30    | 1                  | 100      | 530 (Y) |
| <b>1704405</b> | 24     | 24    | 36    | 1                  | 116      | 530 (Y) |

## White, Dual Latch



| Part No.       | Height | Depth | Width | # Latches per Door | Wt. (lb) | Cat.    |
|----------------|--------|-------|-------|--------------------|----------|---------|
| <b>1702410</b> | 18     | 18    | 48    | 2                  | 118      | 530 (Y) |
| <b>1702415</b> | 18     | 18    | 60    | 2                  | 143      | 530 (Y) |
| <b>1702417</b> | 18     | 18    | 66    | 2                  | 186      | 530 (Y) |
| <b>1708410</b> | 18     | 24    | 48    | 2                  | 133      | 530 (Y) |
| <b>1704410</b> | 24     | 24    | 48    | 2                  | 145      | 530 (Y) |
| <b>1704415</b> | 24     | 24    | 60    | 2                  | 175      | 530 (Y) |

## Primed, Single Latch



| Part No.       | Height | Depth | Width | # Latches per Door | Wt. (lb) | Cat.    |
|----------------|--------|-------|-------|--------------------|----------|---------|
| <b>1703900</b> | 14     | 16    | 24    | 1                  | 56       | 530 (Y) |
| <b>1702900</b> | 18     | 18    | 24    | 1                  | 67       | 530 (Y) |
| <b>1702905</b> | 18     | 18    | 36    | 1                  | 92       | 530 (Y) |

## Primed, Dual Latch



| Part No.       | Height | Depth | Width | # Latches per Door | Wt. (lb) | Cat.    |
|----------------|--------|-------|-------|--------------------|----------|---------|
| <b>1702910</b> | 18     | 18    | 48    | 2                  | 118      | 530 (Y) |

## T-HANDLE OR 3-POINT COMPRESSION LATCH WITH SHELF

- 14 gauge steel box with 12 gauge steel door
- 14 gauge steel shelf welded at mid height, 12-3/4" deep with 1" front lip
- Locking T-handle latches
- Aircraft grade door cables
- Replaceable gasket sealing system

### Black



| Part No.       | Height | Depth | Width | # Latches per Door | Lanyards | Wt. (lb) | Cat.    |
|----------------|--------|-------|-------|--------------------|----------|----------|---------|
| <b>1703304</b> | 14     | 16    | 30    | 1                  | Y        | 72       | 530 (Y) |
| <b>1702306</b> | 18     | 18    | 36    | 1                  | N        | 82       | 530 (Y) |
| <b>1702311</b> | 18     | 18    | 48    | 1                  | N        | 106      | 530 (Y) |

### White



| Part No.       | Height | Depth | Width | # Latches per Door | Lanyards | Wt. (lb) | Cat.    |
|----------------|--------|-------|-------|--------------------|----------|----------|---------|
| <b>1703404</b> | 14     | 16    | 30    | 1                  | Y        | 72       | 530 (Y) |
| <b>1702406</b> | 18     | 18    | 36    | 1                  | N        | 82       | 530 (Y) |
| <b>1702411</b> | 18     | 18    | 48    | 1                  | N        | 106      | 530 (Y) |

## T-HANDLE LATCH WITH SLANTED BACK

- Angled top allows room for fuel fill hoses on single rear wheel flat beds
- Locking stainless steel T-handle latches
- Door opening: flat surface mount (90°) or underbody mount (180°)
- Drop-down recessed door
- Replaceable gasket sealing system

### Black



| Part No.       | Height | Depth | Width | # Latches per Door | Wt. (lb) | Cat.    |
|----------------|--------|-------|-------|--------------------|----------|---------|
| <b>1703351</b> | 14     | 12    | 18    | 1                  | 40       | 530 (Y) |
| <b>1703352</b> | 14     | 12    | 24    | 1                  | 47       | 530 (Y) |
| <b>1703355</b> | 14     | 12    | 30    | 1                  | 49       | 530 (Y) |



See pg. 34-35 for Underbody Mounting Brackets

# Steel Underbody

## PADDLE LATCH

- 14 gauge powder-coated steel box with 12 gauge steel door
- Drop-down recessed door
- Locking stainless steel paddle latch
- Bolt-on continuous hidden hinge
- Replaceable gasket sealing system
- Aircraft grade door cables
- Reinforced door backbone on boxes 48" and wider
- Door opening: flat surface mount (90°) or underbody mount (180°)



### Black, Single Latch



| Part No. | Height | Depth | Width | # Latches per Door | Wt. (lb) | Cat.    |
|----------|--------|-------|-------|--------------------|----------|---------|
| 1703150  | 14     | 12    | 24    | 1                  | 48       | 530 (Y) |
| 1703100  | 14     | 16    | 24    | 1                  | 56       | 530 (Y) |
| 1703103  | 14     | 16    | 30    | 1                  | 65       | 530 (Y) |
| 1702100  | 18     | 18    | 24    | 1                  | 67       | 530 (Y) |
| 1702103  | 18     | 18    | 30    | 1                  | 80       | 530 (Y) |
| 1702105  | 18     | 18    | 36    | 1                  | 92       | 530 (Y) |

### Black, Dual Latch



| Part No. | Height | Depth | Width | # Latches per Door | Wt. (lb) | Cat.    |
|----------|--------|-------|-------|--------------------|----------|---------|
| 1702110  | 18     | 18    | 48    | 2                  | 118      | 530 (Y) |
| 1702115  | 18     | 18    | 60    | 2                  | 143      | 530 (Y) |

### White, Single Latch



| Part No. | Height | Depth | Width | # Latches per Door | Wt. (lb) | Cat.    |
|----------|--------|-------|-------|--------------------|----------|---------|
| 1703203  | 14     | 16    | 30    | 1                  | 65       | 530 (Y) |
| 1703205  | 14     | 16    | 36    | 1                  | 74       | 530 (Y) |
| 1702200  | 18     | 18    | 24    | 1                  | 67       | 530 (Y) |
| 1702203  | 18     | 18    | 30    | 1                  | 80       | 530 (Y) |
| 1702205  | 18     | 18    | 36    | 1                  | 92       | 530 (Y) |

### White, Dual Latch



| Part No. | Height | Depth | Width | # Latches per Door | Wt. (lb) | Cat.    |
|----------|--------|-------|-------|--------------------|----------|---------|
| 1702210  | 18     | 18    | 48    | 2                  | 118      | 530 (Y) |
| 1702215  | 18     | 18    | 60    | 2                  | 143      | 530 (Y) |

## 3-POINT COMPRESSION LATCH

- 14 gauge powder-coated steel box with 12 gauge steel door
- Drop-down recessed door
- Die-cast T-handle compression latch with 3-point locking system
- Bolt-on continuous hidden hinge
- Replaceable gasket sealing system
- Aircraft grade door cables
- Reinforced door backbone on boxes 48" and wider
- Door opening: flat surface mount (90°) or underbody mount (180°)



### Black



| Part No. | Height | Depth | Width | # Latches per Door | Wt. (lb) | Cat.    |
|----------|--------|-------|-------|--------------------|----------|---------|
| 1732300  | 18     | 18    | 24    | 1                  | 59       | 530 (Y) |
| 1732303  | 18     | 18    | 30    | 1                  | 70       | 530 (Y) |
| 1732305  | 18     | 18    | 36    | 1                  | 83       | 530 (Y) |
| 1732310  | 18     | 18    | 48    | 1                  | 118      | 530 (Y) |
| 1732315  | 18     | 18    | 60    | 1                  | 143      | 530 (Y) |
| 1734300  | 24     | 24    | 24    | 1                  | 84       | 530 (Y) |
| 1734303  | 24     | 24    | 30    | 1                  | 95       | 530 (Y) |
| 1734305  | 24     | 24    | 36    | 1                  | 110      | 530 (Y) |

### White



| Part No. | Height | Depth | Width | # Latches per Door | Wt. (lb) | Cat.    |
|----------|--------|-------|-------|--------------------|----------|---------|
| 1732400  | 18     | 18    | 24    | 1                  | 59       | 530 (Y) |
| 1732403  | 18     | 18    | 30    | 1                  | 70       | 530 (Y) |
| 1732405  | 18     | 18    | 36    | 1                  | 83       | 530 (Y) |
| 1734400  | 24     | 24    | 24    | 1                  | 84       | 530 (Y) |
| 1734403  | 24     | 24    | 30    | 1                  | 95       | 530 (Y) |
| 1734405  | 24     | 24    | 36    | 1                  | 110      | 530 (Y) |
| 1702406† | 18     | 18    | 36    | 1                  | 82       | 530 (Y) |
| 1702411† | 18     | 18    | 48    | 1                  | 106      | 530 (Y) |

†Includes shelf (see page 11)

### Textured Matte Black



| Part No. | Height | Depth | Width | # Latches per Door | Wt. (lb) | Cat.    |
|----------|--------|-------|-------|--------------------|----------|---------|
| 1732500  | 18     | 18    | 24    | 1                  | 59       | 530 (Y) |
| 1732503  | 18     | 18    | 30    | 1                  | 70       | 530 (Y) |
| 1732505  | 18     | 18    | 36    | 1                  | 83       | 530 (Y) |
| 1732510  | 18     | 18    | 48    | 1                  | 118      | 530 (Y) |
| 1734500  | 24     | 24    | 24    | 1                  | 84       | 530 (Y) |
| 1734503  | 24     | 24    | 30    | 1                  | 95       | 530 (Y) |
| 1734505  | 24     | 24    | 36    | 1                  | 110      | 530 (Y) |

# Steel Underbody

## POLISHED STAINLESS STEEL DOOR WITH COMPRESSION LATCH

- 14 gauge steel or stainless box with 12 gauge steel door or polished 16 gauge stainless steel door
- Drop-down recessed door
- Locking die-cast T-handle compression latch
- Continuous hidden hinge
- Replaceable gasket sealing system
- Aircraft grade door cables
- Reinforced door backbone on boxes 48" and wider
- Door opening: flat surface mount (90°) or underbody mount (180°)



### Black Box, Single Latch



| Part No. | Height | Depth | Width | # Latches per Door | Wt. (lb) | Cat.    |
|----------|--------|-------|-------|--------------------|----------|---------|
| 1703700  | 14     | 16    | 24    | 1                  | 55       | 530 (Y) |
| 1703703  | 14     | 16    | 30    | 1                  | 64       | 530 (Y) |
| 1703705  | 14     | 16    | 36    | 1                  | 71       | 530 (Y) |
| 1702700  | 18     | 18    | 24    | 1                  | 72       | 530 (Y) |
| 1702703  | 18     | 18    | 30    | 1                  | 81       | 530 (Y) |
| 1702705  | 18     | 18    | 36    | 1                  | 101      | 530 (Y) |
| 1702965* | 18     | 18    | 18    | 1                  | 42       | 530 (Y) |
| 1704700* | 24     | 24    | 24    | 1                  | 70       | 530 (Y) |
| 1704703* | 24     | 24    | 30    | 1                  | 81       | 530 (Y) |
| 1704705  | 24     | 24    | 36    | 1                  | 132      | 530 (Y) |

### Black Box, Dual Latch



| Part No. | Height | Depth | Width | # Latches per Door | Wt. (lb) | Cat.    |
|----------|--------|-------|-------|--------------------|----------|---------|
| 1702710  | 18     | 18    | 48    | 2                  | 110      | 530 (Y) |
| 1702715  | 18     | 18    | 60    | 2                  | 132      | 530 (Y) |
| 1704710  | 24     | 24    | 48    | 2                  | 169      | 530 (Y) |
| 1704715  | 24     | 24    | 60    | 2                  | 227      | 530 (Y) |
| 1708710* | 18     | 24    | 48    | 2                  | 108      | 530 (Y) |

### Black Box, Double Door



| Part No. | Height | Depth | Width | # Latches per Door | Wt. (lb) | Cat.    |
|----------|--------|-------|-------|--------------------|----------|---------|
| 1702725  | 18     | 18    | 72    | 1                  | 156      | 530 (Y) |

\* **NEW** PRODUCTS



## Stainless Box, Single Latch



| Part No. | Height | Depth | Width | # Latches per Door | Wt. (lb) | Cat.    |
|----------|--------|-------|-------|--------------------|----------|---------|
| 1702595  | 18     | 18    | 18    | 1                  | 51.5     | 530 (Y) |
| 1702600  | 18     | 18    | 24    | 1                  | 61.5     | 530 (Y) |
| 1702603  | 18     | 18    | 30    | 1                  | 81       | 530 (Y) |
| 1702605  | 18     | 18    | 36    | 1                  | 85       | 530 (Y) |
| 1704600  | 24     | 24    | 24    | 1                  | 87       | 530 (Y) |
| 1704603  | 24     | 24    | 30    | 1                  | 100      | 530 (Y) |
| 1704605  | 24     | 24    | 36    | 1                  | 116      | 530 (Y) |

## Stainless Box, Dual Latch



| Part No. | Height | Depth | Width | # Latches per Door | Wt. (lb) | Cat.    |
|----------|--------|-------|-------|--------------------|----------|---------|
| 1702610  | 18     | 18    | 48    | 2                  | 110      | 530 (Y) |
| 1704610  | 24     | 24    | 48    | 2                  | 145      | 530 (Y) |
| 1704615  | 24     | 24    | 60    | 2                  | 175      | 530 (Y) |



See pg. 34-35 for Underbody Mounting Brackets

# Steel Underbody

## MIRROR FINISH STAINLESS STEEL DOOR WITH COMPRESSION LATCH

- 16 gauge high polish steel box and door
- Drop-down external door
- Locking die-cast T-handle compression latch
- Continuous hidden hinge
- Replaceable door cables
- Built-in rain gutter with automotive bulb seal



### Single Latch



| Part No. | Height | Depth | Width | # Latches per Door | Wt. (lb) | Cat.    |
|----------|--------|-------|-------|--------------------|----------|---------|
| 1702650  | 18     | 18    | 24    | 1                  | 48       | 530 (N) |
| 1702653  | 18     | 18    | 30    | 1                  | 57       | 530 (N) |
| 1702655  | 18     | 18    | 36    | 1                  | 65       | 530 (N) |

### Dual Latch



| Part No. | Height | Depth | Width | # Latches per Door | Wt. (lb) | Cat.    |
|----------|--------|-------|-------|--------------------|----------|---------|
| 1702660  | 18     | 18    | 48    | 2                  | 80       | 530 (N) |



## DIAMOND TREAD ALUMINUM DOOR WITH COMPRESSION LATCH

- 14 gauge steel box with .100" thick diamond tread door
- Drop-down recessed door
- Locking die-cast T-handle compression latch
- Bolt-on continuous hidden hinge
- Replaceable gasket sealing system
- Aircraft grade door cables
- Door opening: flat surface mount (90°) or underbody mount (180°)
- Reinforced door backbone on boxes 48" and wider



### Black, Single Latch



| Part No.       | Height | Depth | Width | # Latches per Door | Wt. (lb) | Cat.    |
|----------------|--------|-------|-------|--------------------|----------|---------|
| <b>1702500</b> | 18     | 18    | 24    | 1                  | 61       | 530 (Y) |
| <b>1702503</b> | 18     | 18    | 30    | 1                  | 72       | 530 (Y) |
| <b>1702505</b> | 18     | 18    | 36    | 1                  | 82       | 530 (Y) |

### Black, Dual Latch



| Part No.       | Height | Depth | Width | # Latches per Door | Wt. (lb) | Cat.    |
|----------------|--------|-------|-------|--------------------|----------|---------|
| <b>1702510</b> | 18     | 18    | 48    | 2                  | 104      | 530 (Y) |



See pg. 34-35 for Underbody Mounting Brackets

**PRO SERIES**  
**ALUMINUM TRUCK**  
**TOOL BOXES**

**MAXIMUM DURABILITY**  
**MAXIMUM PROTECTION**



1706405  
18x18x36 Drop Down

**PRO SERIES DURABILITY**



0.125" Aluminum with extruded door frame for maximum strength

**PRO SERIES PROTECTION**



Rain gutter with automotive bulb seal keeps gear dry

**PRO SERIES SECURITY**



Locking 3-Point compression latch keeps gear safe

**PRO SERIES RELIABILITY**



Corrosion resistant stainless steel bolt-on hinge

# ALL THE FEATURES A *PRO* WOULD DEMAND

## PRO SERIES UNDERBODY



VS

## STANDARD UNDERBODY



**Maximum Material Thickness** 0.125" Aluminum with Extruded Door Frame

**Maximum Security** Locking 3-Point Compression Latch

**Maximum Weather Protection** Rain Gutter with Automotive Bulb Seal

**Hinge** Stainless Steel Bolt-On Hinge with a 1/4" Pin

**Door** Offset Door

**Material Thickness** 0.100" Aluminum

**Security** Locking Compression Latch

**Weather Protection** Weather Resistant Seal

**Hinge** Aluminum Hinge

**Door** Recessed Door

# PRO Series Aluminum Underbody

## DROP DOOR WITH 3-POINT COMPRESSION LATCH

- .125" thick smooth aluminum with rigid extruded box frame (.100" thick diamond tread aluminum door on certain models)
- Die-cast T-handle compression latch with 3-point locking system
- Stainless steel bolt-on continuous hinge with oversized 1/4" pin
- Built-in rain gutter with automotive bulb seal

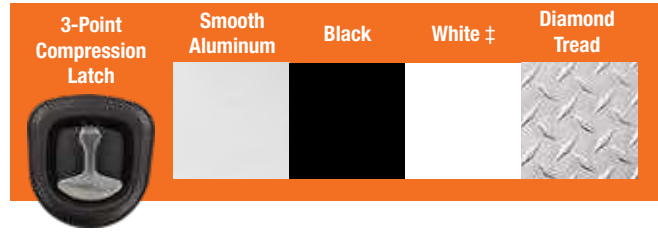

### Smooth Aluminum



| Part No. | Height | Depth | Width | # Latches per Door | Wt. (lb) | Cat.    |
|----------|--------|-------|-------|--------------------|----------|---------|
| 1706400  | 18     | 18    | 24    | 1                  | 44       | 530 (Y) |
| 1706403  | 18     | 18    | 30    | 1                  | 50       | 530 (Y) |
| 1706405  | 18     | 18    | 36    | 1                  | 57       | 530 (Y) |
| 1706410  | 18     | 18    | 48    | 1                  | 64       | 530 (Y) |
| 1706415  | 18     | 18    | 60    | 1                  | 78       | 530 (Y) |
| 1706420  | 18     | 24    | 36    | 1                  | 57       | 530 (Y) |
| 1706425  | 18     | 24    | 48    | 1                  | 79       | 530 (Y) |
| 1706430  | 18     | 24    | 60    | 1                  | 83       | 530 (Y) |

### Black



| Part No. | Height | Depth | Width | # Latches per Door | Wt. (lb) | Cat.    |
|----------|--------|-------|-------|--------------------|----------|---------|
| 1706960  | 18     | 18    | 24    | 1                  | 44       | 530 (Y) |
| 1706963  | 18     | 18    | 30    | 1                  | 50       | 530 (Y) |
| 1706965  | 18     | 18    | 36    | 1                  | 57       | 530 (Y) |
| 1706970  | 18     | 18    | 48    | 1                  | 64       | 530 (Y) |
| 1706975  | 18     | 18    | 60    | 1                  | 78       | 530 (Y) |
| 1706980  | 18     | 24    | 36    | 1                  | 57       | 530 (Y) |
| 1706985  | 18     | 24    | 48    | 1                  | 79       | 530 (Y) |
| 1706990  | 18     | 24    | 60    | 1                  | 83       | 530 (Y) |

### White‡



| Part No. | Height | Depth | Width | # Latches per Door | Wt. (lb) | Cat.    |
|----------|--------|-------|-------|--------------------|----------|---------|
| 1707960‡ | 18     | 18    | 24    | 1                  | 44       | 530 (Y) |
| 1707963‡ | 18     | 18    | 30    | 1                  | 50       | 530 (Y) |
| 1707965‡ | 18     | 18    | 36    | 1                  | 57       | 530 (Y) |
| 1707970‡ | 18     | 18    | 48    | 1                  | 64       | 530 (Y) |
| 1707975‡ | 18     | 18    | 60    | 1                  | 78       | 530 (Y) |
| 1707980‡ | 18     | 24    | 36    | 1                  | 57       | 530 (Y) |
| 1707985‡ | 18     | 24    | 48    | 1                  | 79       | 530 (Y) |
| 1707990‡ | 18     | 24    | 60    | 1                  | 83       | 530 (Y) |

‡ White is not stocked. Please call for lead time.

# PRO Series Aluminum Underbody

## Diamond Tread Door



| Part No. | Height | Depth | Width | # Latches per Door | Wt. (lb) | Cat.    |
|----------|--------|-------|-------|--------------------|----------|---------|
| 1706500  | 18     | 18    | 24    | 1                  | 41       | 530 (Y) |
| 1706503  | 18     | 18    | 30    | 1                  | 48       | 530 (Y) |
| 1706505  | 18     | 18    | 36    | 1                  | 56       | 530 (Y) |
| 1706510  | 18     | 18    | 48    | 1                  | 69       | 530 (Y) |
| 1706515  | 18     | 18    | 60    | 1                  | 79       | 530 (Y) |
| 1706520  | 18     | 24    | 36    | 1                  | 67       | 530 (Y) |
| 1706525  | 18     | 24    | 48    | 1                  | 80       | 530 (Y) |
| 1706530  | 18     | 24    | 60    | 1                  | 84       | 530 (Y) |



See pg. 34-35 for Underbody Mounting Brackets

# PRO Series Aluminum Underbody

## SMOOTH ALUMINUM BARN DOOR WITH COMPRESSION LATCH

- .125" thick smooth aluminum with rigid extruded box frame
- Locking die-cast T-handle compression latch
- 3 point locking system on double barn doors, standard lock system on single swing door
- Stainless steel bolt-on continuous hinge with oversized 1/4" pin
- Built-in rain gutter with automotive bulb seal
- Unobstructed box opening with no center post

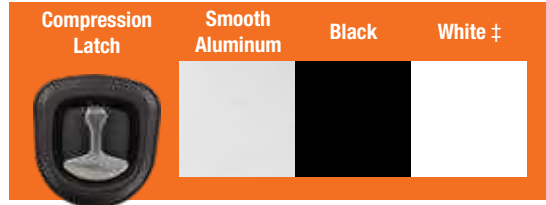

### Smooth Aluminum



| Part No. | Height | Depth | Width | # Doors | Wt. (lb) | Cat.    |
|----------|--------|-------|-------|---------|----------|---------|
| 1705395  | 18     | 18    | 18    | 1       | 56.5     | 530 (Y) |
| 1705401  | 18     | 18    | 24    | 1       | 56.5     | 530 (Y) |
| 1705403  | 18     | 18    | 30    | 2       | 45       | 530 (Y) |
| 1705405  | 18     | 18    | 36    | 2       | 51       | 530 (Y) |
| 1705410  | 18     | 18    | 48    | 2       | 62       | 530 (Y) |
| 1705415  | 18     | 18    | 60    | 2       | 73       | 530 (Y) |
| 1705420  | 18     | 24    | 36    | 2       | 58       | 530 (Y) |
| 1705425  | 18     | 24    | 48    | 2       | 71       | 530 (Y) |
| 1705430  | 18     | 24    | 60    | 2       | 85       | 530 (Y) |
| 1705431  | 24     | 24    | 24    | 1       | 67       | 530 (Y) |
| 1705433  | 24     | 24    | 30    | 2       | 62       | 530 (Y) |
| 1705435  | 24     | 24    | 36    | 2       | 67       | 530 (Y) |
| 1705440  | 24     | 24    | 48    | 2       | 83       | 530 (Y) |
| 1705445  | 24     | 24    | 60    | 2       | 99       | 530 (Y) |
| 1705450  | 24     | 24    | 72    | 2       | 105      | 530 (Y) |

### Black



| Part No. | Height | Depth | Width | # Doors | Wt. (lb) | Cat.    |
|----------|--------|-------|-------|---------|----------|---------|
| 1705895  | 18     | 18    | 18    | 1       | 56.5     | 530 (Y) |
| 1705900  | 18     | 18    | 24    | 1       | 56.5     | 530 (Y) |
| 1705903  | 18     | 18    | 18    | 2       | 45       | 530 (Y) |
| 1705905  | 18     | 18    | 36    | 2       | 51       | 530 (Y) |
| 1705910  | 18     | 18    | 48    | 2       | 62       | 530 (Y) |
| 1705915  | 18     | 18    | 60    | 2       | 73       | 530 (Y) |
| 1705920  | 18     | 24    | 36    | 2       | 58       | 530 (Y) |
| 1705925  | 18     | 24    | 48    | 2       | 71       | 530 (Y) |
| 1705930  | 18     | 24    | 60    | 2       | 85       | 530 (Y) |
| 1705931  | 24     | 24    | 24    | 1       | 67       | 530 (Y) |
| 1705933* | 24     | 24    | 30    | 2       | 62       | 530 (Y) |
| 1705935  | 24     | 24    | 36    | 2       | 67       | 530 (Y) |
| 1705940  | 24     | 24    | 48    | 2       | 83       | 530 (Y) |
| 1705945  | 24     | 24    | 60    | 2       | 99       | 530 (Y) |
| 1705950  | 24     | 24    | 72    | 2       | 105      | 530 (Y) |



# PRO Series Aluminum Underbody

White‡



| Part No. | Height | Depth | Width | # Doors | Wt. (lb) | Cat.    |
|----------|--------|-------|-------|---------|----------|---------|
| 1706895‡ | 18     | 18    | 18    | 1       | 56.5     | 530 (Y) |
| 1706900‡ | 18     | 18    | 24    | 1       | 56.5     | 530 (Y) |
| 1706903‡ | 18     | 18    | 30    | 2       | 45       | 530 (Y) |
| 1706905‡ | 18     | 18    | 36    | 2       | 51       | 530 (Y) |
| 1706910‡ | 18     | 18    | 48    | 2       | 62       | 530 (Y) |
| 1706915‡ | 18     | 18    | 60    | 2       | 73       | 530 (Y) |
| 1706920‡ | 18     | 24    | 36    | 2       | 58       | 530 (Y) |
| 1706925‡ | 18     | 24    | 48    | 2       | 71       | 530 (Y) |
| 1706930‡ | 18     | 24    | 60    | 2       | 85       | 530 (Y) |
| 1706931‡ | 24     | 24    | 24    | 1       | 67       | 530 (Y) |
| 1706933‡ | 24     | 24    | 30    | 2       | 62       | 530 (Y) |
| 1706935‡ | 24     | 24    | 36    | 2       | 67       | 530 (Y) |
| 1706940‡ | 24     | 24    | 48    | 2       | 83       | 530 (Y) |
| 1706945‡ | 24     | 24    | 60    | 2       | 99       | 530 (Y) |
| 1706950‡ | 24     | 24    | 72    | 2       | 105      | 530 (Y) |

‡ White is not stocked. Please call for lead time.



See pg. 34-35 for Underbody Mounting Brackets

# Cam Lock Underbodies

**ALL NEW**



.125" thick smooth aluminum

Built-in rain gutter with automotive bulb seal

1763103

Side-hinged doors with reversible right/left locking door

Stainless steel bolt-on continuous hinge with oversized 1/4" pin



## Cam Lock Features



Side-hinged doors with reversible right/left locking door



Built-in rain gutter with automotive bulb seal

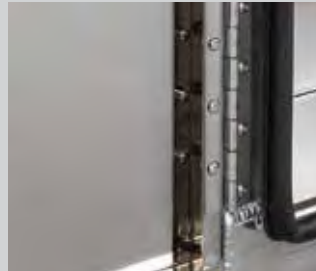

Stainless steel bolt-on continuous hinge with oversized 1/4" pin



Unobstructed box opening

## BARN DOOR WITH CAM LATCH

- 0.125" thick smooth aluminum
- Unobstructed box opening with no center post
- Cam-Lock hardware is made of high-quality aluminum and allows for the use of a personal padlock (purchased separately)
- Designed for universal installation (divers side or passenger side)
- Stainless steel bolt-on continuous hinge with oversized 1/4" pin
- Built-in rain gutter with automotive bulb seal
- Ideal for Flat Bed Trailer Applications

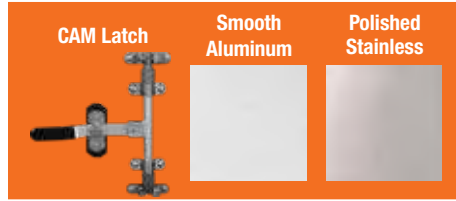

### Smooth Aluminum Doors



| Part No. | Height | Depth | Width | # Doors | Wt. (lb) | Cat.    |
|----------|--------|-------|-------|---------|----------|---------|
| 1762600* | 18     | 18    | 36    | 2       | 55       | 530 (Y) |
| 1762603* | 18     | 18    | 48    | 2       | 65       | 530 (Y) |
| 1762606* | 18     | 18    | 60    | 2       | 76       | 530 (Y) |
| 1762609* | 18     | 18    | 72    | 2       | 87       | 530 (Y) |
| 1762621* | 18     | 24    | 36    | 2       | 63       | 530 (Y) |
| 1762624* | 18     | 24    | 48    | 2       | 75       | 530 (Y) |
| 1762627* | 18     | 24    | 60    | 2       | 88       | 530 (Y) |
| 1762630* | 18     | 24    | 72    | 2       | 101      | 530 (Y) |
| 1762639* | 24     | 24    | 36    | 2       | 73       | 530 (Y) |
| 1762642* | 24     | 24    | 48    | 2       | 87       | 530 (Y) |
| 1762645* | 24     | 24    | 60    | 2       | 102      | 530 (Y) |
| 1762648* | 24     | 24    | 72    | 2       | 116      | 530 (Y) |

### Polished Stainless Steel Doors



| Part No. | Height | Depth | Width | # Doors | Wt. (lb) | Cat.    |
|----------|--------|-------|-------|---------|----------|---------|
| 1763100* | 18     | 18    | 36    | 2       | 55       | 530 (Y) |
| 1763103* | 18     | 18    | 48    | 2       | 65       | 530 (Y) |
| 1763106* | 18     | 18    | 60    | 2       | 84       | 530 (Y) |
| 1763109* | 18     | 18    | 72    | 2       | 97       | 530 (Y) |
| 1763121* | 18     | 24    | 36    | 2       | 63       | 530 (Y) |
| 1763124* | 18     | 24    | 48    | 2       | 75       | 530 (Y) |
| 1763127* | 18     | 24    | 60    | 2       | 96       | 530 (Y) |
| 1763130* | 18     | 24    | 72    | 2       | 110      | 530 (Y) |
| 1763139* | 24     | 24    | 36    | 2       | 73       | 530 (Y) |
| 1763142* | 24     | 24    | 48    | 2       | 87       | 530 (Y) |
| 1763145* | 24     | 24    | 60    | 2       | 110      | 530 (Y) |
| 1763148* | 24     | 24    | 72    | 2       | 125      | 530 (Y) |

\* **NEW** PRODUCTS



See pg. 34-35 for Underbody Mounting Brackets

# Aluminum Underbody

## BARN DOOR WITH COMPRESSION LATCH

- 0.100" thick diamond tread or smooth aluminum
- Side-hinged doors with reversible right/left locking door
- Locking die-cast T-handle compression latch
- 3 point locking system on double barn doors, standard lock system on single swing door
- Aluminum bolt-on continuous hinge with oversize 1/4" pin
- Automotive D-bulb seal
- Can mount on flat surface
- Unobstructed box opening with no center post

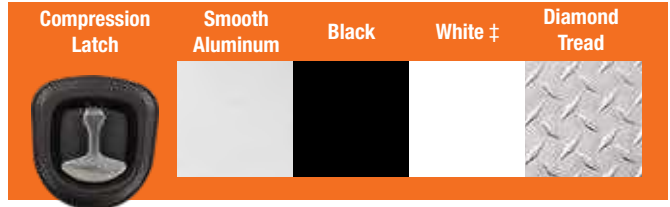

### Smooth Aluminum



| Part No. | Height | Depth | Width | # Doors | Wt. (lb) | Cat.    |
|----------|--------|-------|-------|---------|----------|---------|
| 1705295  | 18     | 18    | 18    | 1       | 26       | 530 (Y) |
| 1705300  | 18     | 18    | 24    | 1       | 32       | 530 (Y) |
| 1705303  | 18     | 18    | 30    | 2       | 42       | 530 (Y) |
| 1705305  | 18     | 18    | 36    | 2       | 49       | 530 (Y) |
| 1705310  | 18     | 18    | 48    | 2       | 63       | 530 (Y) |
| 1705315  | 18     | 18    | 60    | 2       | 77       | 530 (Y) |
| 1705325  | 24     | 24    | 24    | 1       | 43       | 530 (Y) |
| 1705333  | 24     | 24    | 30    | 2       | 69       | 530 (Y) |
| 1705335  | 24     | 24    | 36    | 2       | 75       | 530 (Y) |
| 1705340  | 24     | 24    | 48    | 2       | 87       | 530 (Y) |
| 1705345  | 24     | 24    | 60    | 2       | 99       | 530 (Y) |
| 1705350  | 24     | 24    | 72    | 2       | 98       | 530 (Y) |

### Black



| Part No. | Height | Depth | Width | # Doors | Wt. (lb) | Cat.    |
|----------|--------|-------|-------|---------|----------|---------|
| 1705795  | 18     | 18    | 18    | 1       | 26       | 530 (Y) |
| 1705800  | 18     | 18    | 24    | 1       | 32       | 530 (Y) |
| 1705803  | 18     | 18    | 30    | 2       | 42       | 530 (Y) |
| 1705805  | 18     | 18    | 36    | 2       | 49       | 530 (Y) |
| 1705810  | 18     | 18    | 48    | 2       | 63       | 530 (Y) |
| 1705815  | 18     | 18    | 60    | 2       | 77       | 530 (Y) |
| 1705825  | 24     | 24    | 24    | 1       | 43       | 530 (Y) |
| 1705833  | 24     | 24    | 30    | 2       | 69       | 530 (Y) |
| 1705835  | 24     | 24    | 36    | 2       | 75       | 530 (Y) |
| 1705840  | 24     | 24    | 48    | 2       | 87       | 530 (Y) |
| 1705845  | 24     | 24    | 60    | 2       | 99       | 530 (Y) |
| 1705850  | 24     | 24    | 72    | 2       | 98       | 530 (Y) |

### White‡



| Part No. | Height | Depth | Width | # Doors | Wt. (lb) | Cat.    |
|----------|--------|-------|-------|---------|----------|---------|
| 1706795‡ | 18     | 18    | 18    | 1       | 26       | 530 (Y) |
| 1706800‡ | 18     | 18    | 24    | 1       | 32       | 530 (Y) |
| 1706803‡ | 18     | 18    | 30    | 2       | 42       | 530 (Y) |
| 1706805‡ | 18     | 18    | 36    | 2       | 49       | 530 (Y) |
| 1706810‡ | 18     | 18    | 48    | 2       | 63       | 530 (Y) |
| 1706815‡ | 18     | 18    | 60    | 2       | 77       | 530 (Y) |
| 1706825‡ | 24     | 24    | 24    | 1       | 43       | 530 (Y) |
| 1706833‡ | 24     | 24    | 30    | 2       | 69       | 530 (Y) |
| 1706835‡ | 24     | 24    | 36    | 2       | 75       | 530 (Y) |
| 1706840‡ | 24     | 24    | 48    | 2       | 87       | 530 (Y) |
| 1706845‡ | 24     | 24    | 60    | 2       | 99       | 530 (Y) |
| 1706850‡ | 24     | 24    | 72    | 2       | 98       | 530 (Y) |

‡ White is not stocked. Please call for lead time.

# Aluminum Underbody

## Diamond Tread Aluminum



| Part No. | Height | Depth | Width | # Doors | Wt. (lb) | Cat.    |
|----------|--------|-------|-------|---------|----------|---------|
| 1705201  | 18     | 18    | 18    | 1       | 27       | 530 (Y) |
| 1705200  | 18     | 18    | 24    | 1       | 36       | 530 (Y) |
| 1705203  | 18     | 18    | 30    | 1       | 42       | 530 (Y) |
| 1702230  | 24     | 24    | 30    | 1       | 52       | 530 (Y) |
| 1705205  | 18     | 18    | 36    | 2       | 49       | 530 (Y) |
| 1705210  | 18     | 18    | 48    | 2       | 63       | 530 (Y) |
| 1705215  | 18     | 18    | 60    | 2       | 77       | 530 (Y) |
| 1702225  | 24     | 24    | 24    | 1       | 45       | 530 (Y) |
| 1702235  | 24     | 24    | 36    | 2       | 71       | 530 (Y) |
| 1702240  | 24     | 24    | 48    | 2       | 76       | 530 (Y) |
| 1702250  | 24     | 24    | 60    | 2       | 87       | 530 (Y) |



See pg. 34-35 for Underbody Mounting Brackets

# Aluminum Underbody

## COMPRESSION LATCH

- .100" thick diamond tread aluminum
- Drop-down recessed door
- Locking die-cast T-handle compression latch
- Aluminum bolt-on continuous hidden hinge
- Replaceable gasket sealing system
- Aircraft grade door cables
- Reinforced door backbone on boxes 48" and wider
- Door opening: flat surface mount (90°) or underbody mount (180°)



### Diamond Tread, Single Latch



| Part No. | Height | Depth | Width | # Latches per Door | Wt. (lb) | Cat.    |
|----------|--------|-------|-------|--------------------|----------|---------|
| 1705148  | 14     | 12    | 16    | 1                  | 18       | 530 (Y) |
| 1705149  | 14     | 12    | 18    | 1                  | 19       | 530 (Y) |
| 1705150  | 14     | 12    | 24    | 1                  | 23       | 530 (Y) |
| 1705153  | 14     | 12    | 30    | 1                  | 26       | 530 (Y) |
| 1705160  | 14     | 16    | 24    | 1                  | 25       | 530 (Y) |
| 1705102  | 18     | 18    | 14    | 1                  | 25       | 530 (Y) |
| 1705101  | 18     | 18    | 18    | 1                  | 30       | 530 (Y) |
| 1705100  | 18     | 18    | 24    | 1                  | 33       | 530 (Y) |
| 1705103  | 18     | 18    | 30    | 1                  | 39       | 530 (Y) |
| 1705105  | 18     | 18    | 36    | 1                  | 43       | 530 (Y) |
| 1705118  | 20     | 20    | 36    | 1                  | 46       | 530 (Y) |
| 1705119  | 18     | 24    | 36    | 1                  | 56       | 530 (Y) |
| 1705130  | 24     | 24    | 24    | 1                  | 45       | 530 (Y) |
| 1705133  | 24     | 24    | 30    | 1                  | 52       | 530 (Y) |
| 1705135  | 24     | 24    | 36    | 1                  | 60       | 530 (Y) |

### Diamond Tread, Dual Latch



| Part No. | Height | Depth | Width | # Latches per Door | Wt. (lb) | Cat.    |
|----------|--------|-------|-------|--------------------|----------|---------|
| 1705110  | 18     | 18    | 48    | 2                  | 57       | 530 (Y) |
| 1705115  | 18     | 18    | 60    | 2                  | 66       | 530 (Y) |
| 1705120  | 18     | 24    | 48    | 2                  | 64       | 530 (Y) |
| 1705125  | 18     | 24    | 60    | 2                  | 82       | 530 (Y) |
| 1705140  | 24     | 24    | 48    | 2                  | 75       | 530 (Y) |
| 1705145  | 24     | 24    | 60    | 2                  | 89       | 530 (Y) |
| 1705147  | 24     | 24    | 72    | 2                  | 97       | 530 (Y) |

## Black Diamond Tread, Single Latch



| Part No. | Height | Depth | Width | # Latches per Door | Wt. (lb) | Cat.    |
|----------|--------|-------|-------|--------------------|----------|---------|
| 1725148  | 14     | 12    | 16    | 1                  | 18       | 530 (Y) |
| 1725149  | 14     | 12    | 18    | 1                  | 23       | 503 (Y) |
| 1725150  | 14     | 12    | 24    | 1                  | 25       | 530 (Y) |
| 1725153  | 14     | 12    | 30    | 1                  | 27       | 530 (Y) |
| 1725160  | 14     | 16    | 24    | 1                  | 26       | 530 (Y) |
| 1725102  | 18     | 18    | 14    | 1                  | 27       | 530 (Y) |
| 1725101  | 18     | 18    | 18    | 1                  | 27       | 530 (Y) |
| 1725100  | 18     | 18    | 24    | 1                  | 30       | 530 (Y) |
| 1725103  | 18     | 18    | 30    | 1                  | 38       | 530 (Y) |
| 1725105  | 18     | 18    | 36    | 1                  | 42       | 530 (Y) |
| 1725116  | 18     | 24    | 30    | 1                  | 40       | 530 (Y) |
| 1725119  | 18     | 24    | 36    | 1                  | 56       | 530 (Y) |
| 1725125  | 18     | 24    | 60    | 1                  | 64       | 530 (Y) |
| 1725118  | 20     | 20    | 36    | 1                  | 64       | 530 (Y) |
| 1725130  | 24     | 24    | 24    | 1                  | 46       | 530 (Y) |
| 1725133  | 24     | 24    | 30    | 1                  | 53       | 530 (Y) |
| 1725135  | 24     | 24    | 36    | 1                  | 59       | 530 (Y) |

## Black Diamond Tread, Dual Latch



| Part No. | Height | Depth | Width | # Latches per Door | Wt. (lb) | Cat.    |
|----------|--------|-------|-------|--------------------|----------|---------|
| 1725110  | 18     | 18    | 48    | 2                  | 52       | 530 (Y) |
| 1725115  | 18     | 18    | 60    | 2                  | 70       | 530 (Y) |
| 1725120  | 18     | 24    | 48    | 2                  | 64       | 530 (Y) |
| 1725140  | 24     | 24    | 48    | 2                  | 76       | 530 (Y) |
| 1725145  | 24     | 24    | 60    | 2                  | 89       | 530 (Y) |
| 1725147  | 24     | 24    | 72    | 2                  | 97       | 530 (Y) |

## Textured Matte Black Diamond Tread, Single Latch



| Part No. | Height | Depth | Width | # Latches per Door | Wt. (lb) | Cat.    |
|----------|--------|-------|-------|--------------------|----------|---------|
| 1715100  | 18     | 18    | 24    | 1                  | 30       | 530 (Y) |
| 1715105  | 18     | 18    | 36    | 1                  | 42       | 530 (Y) |

## Textured Matte Black Diamond Tread, Dual Latch



| Part No. | Height | Depth | Width | # Latches per Door | Wt. (lb) | Cat.    |
|----------|--------|-------|-------|--------------------|----------|---------|
| 1715110  | 18     | 18    | 48    | 2                  | 52       | 530 (Y) |
| 1715115  | 18     | 18    | 60    | 2                  | 70       | 530 (Y) |

# Aluminum Underbody

## 3-POINT COMPRESSION LATCH

- .100" thick diamond tread aluminum
- Drop-down recessed door
- Die-cast T-handle compression latch with 3-point locking system
- Aluminum bolt-on continuous hidden hinge
- Replaceable gasket sealing system
- Aircraft grade door cables
- Reinforced door backbone
- Door opening: flat surface mount (90°) or underbody mount (180°)



## Diamond Tread



| Part No. | Height | Depth | Width | # Latches per Door | Wt. (lb) | Cat.    |
|----------|--------|-------|-------|--------------------|----------|---------|
| 1735100  | 18     | 18    | 24    | 1                  | 33       | 530 (Y) |
| 1735103  | 18     | 18    | 30    | 1                  | 38       | 530 (Y) |
| 1735105  | 18     | 18    | 36    | 1                  | 44       | 530 (Y) |
| 1735130  | 24     | 24    | 24    | 1                  | 45       | 530 (Y) |
| 1735133  | 24     | 24    | 30    | 1                  | 58       | 530 (Y) |
| 1735135  | 24     | 24    | 36    | 1                  | 63       | 530 (Y) |

## ALUMINUM UNDERBODY WITH DRAWERS

- .100" thick diamond tread aluminum
- Drawer comes with adjustable dividers and 100 lb rated 16" slides
- Drop-down recessed door
- Locking die-cast T-handle compression latch
- Continuous hidden hinge
- Replaceable gasket sealing system
- Door opening: flat surface mount (90°) or underbody mount (180°)
- Reinforced door backbone
- Aircraft grade door cables



| Part No. | Height | Depth | Width | # Latches per Door | Wt. (lb) | Cat.    |
|----------|--------|-------|-------|--------------------|----------|---------|
| 1712200  | 20     | 18    | 24    | 1                  | 50       | 530 (Y) |
| 1712205  | 20     | 18    | 36    | 1                  | 66       | 530 (Y) |
| 1712210  | 20     | 18    | 48    | 1                  | 85       | 530 (Y) |



## 3-POINT T-HANDLE LATCH

### Black, Single Latch

- Constructed of high-density polyethylene
- Drop down door
- Locking stainless steel 3-point T-handle latch
- Stainless steel hinge pin
- Replaceable gasket sealing system
- Aircraft grade door cables
- Molded double-wall door design



| Part No. | Height | Depth | Width | # Latches per Door | Wt. (lb) | Cat.    |
|----------|--------|-------|-------|--------------------|----------|---------|
| 1717100  | 18     | 18    | 24    | 1                  | 24       | 530 (Y) |
| 1717105  | 18     | 18    | 36    | 1                  | 31       | 530 (Y) |
| 1717110  | 18     | 18    | 48    | 1                  | 42       | 530 (Y) |



See pg. 34-35 for Underbody Mounting Brackets

# Underbody Mounting Brackets

## STEEL

- Sold in boxed pairs
- Universal hole pattern for quick and easy mounting
- Available with welded braces or bolt-on braces
- Available in heavy-duty structural steel (optional)
- Constructed of formed (optional) 3" wide steel C-channel, black powder-coated for corrosion resistance
- Hardware not included

### Formed, Welded



1701006

| Part No. | Description            | Height | Depth | Wt. (lb) | Cat.    |
|----------|------------------------|--------|-------|----------|---------|
| 1701006  | Formed Welded Brackets | 18     | 18    | 16       | 531 (Y) |
| 1701011  | Formed Welded Brackets | 18     | 24    | 19       | 531 (Y) |
| 1701016  | Formed Welded Brackets | 24     | 24    | 22       | 531 (Y) |

### Formed, Bolted



1701006B

| Part No. | Description            | Height | Depth | Wt. (lb) | Cat.    |
|----------|------------------------|--------|-------|----------|---------|
| 1701006B | Formed Bolted Brackets | 18     | 18    | 16       | 531 (Y) |
| 1701011B | Formed Bolted Brackets | 18     | 24    | 19       | 531 (Y) |

### Heavy Duty, Structural Welded

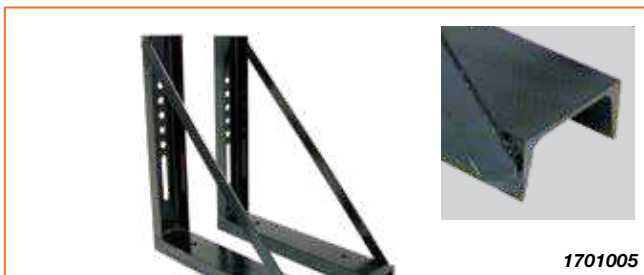

1701005

| Part No. | Description                | Height | Depth | Wt. (lb) | Cat.    |
|----------|----------------------------|--------|-------|----------|---------|
| 1701005  | Structural Welded Brackets | 18     | 18    | 24       | 531 (Y) |
| 1701010  | Structural Welded Brackets | 18     | 24    | 27       | 531 (Y) |
| 1701015  | Structural Welded Brackets | 24     | 24    | 32       | 531 (Y) |
| 1701012  | Structural Welded Brackets | 27     | 18    | 47       | 531 (Y) |

### Heavy Duty, Structural Bolted



1701005B

| Part No. | Description                | Height | Depth | Wt. (lb) | Cat.    |
|----------|----------------------------|--------|-------|----------|---------|
| 1701005B | Structural Bolted Brackets | 18     | 18    | 24       | 531 (Y) |
| 1701010B | Structural Bolted Brackets | 18     | 24    | 27       | 531 (Y) |

# Underbody Mounting Brackets

## STAINLESS STEEL

- Sold in boxed pairs
- Universal hole pattern for quick and easy mounting
- Welded braces
- 3/16" thick 304 stainless steel construction
- Hardware not included

### Formed, Welded



1701031

| Part No. | Description     | Height | Depth | Wt. (lb) | Cat.    |
|----------|-----------------|--------|-------|----------|---------|
| 1701031  | Welded Brackets | 18     | 18    | 19       | 531 (Y) |
| 1701041  | Welded Brackets | 18     | 24    | 22       | 531 (Y) |

## ALUMINUM

- Sold in boxed pairs
- Welded braces
- Aluminum construction
- 1/4" formed aluminum angles

### Formed, Welded

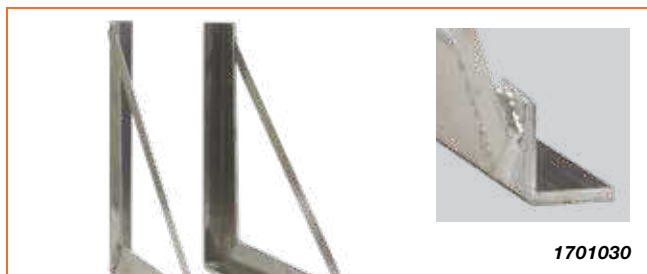

1701030

| Part No. | Description     | Height | Depth | Wt. (lb) | Cat.    |
|----------|-----------------|--------|-------|----------|---------|
| 1701030  | Welded Brackets | 18     | 18    | 7.5      | 531 (Y) |
| 1701040  | Welded Brackets | 24     | 24    | 10       | 531 (Y) |

## FOR POLYMER UNDERBODIES

- Sold in boxed pairs
- Constructed of 3/16" thick 2" wide C-channel A-36 steel
- Black powder-coated
- Channel fits inside toolbox ribs
- Pre-drilled 7/16" mounting holes (nuts/bolts not included)

### Formed, Welded



1701000

| Part No. | Description                   | Height | Depth | Wt. (lb) | Cat.    |
|----------|-------------------------------|--------|-------|----------|---------|
| 1701000  | Brackets for 24" and 36" Poly | 15     | 14    | 14.3     | 530 (Y) |
| 1701001  | Brackets for 48" Poly         | 15     | 14    | 22.3     | 530 (Y) |



TO



# PSIDER

# Topsiders



## PRO SERIES STEEL TOPSIDERS

### Black, Double Door

\* See page 6-7 for details

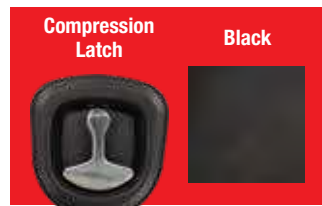

| Part No. | Height | Depth | Width | # Latches per Door | Wt. (lb) | Cat.    |
|----------|--------|-------|-------|--------------------|----------|---------|
| 1752815† | 18     | 18    | 60    | 1                  | 175      | 530 (Y) |
| 1752825† | 18     | 18    | 72    | 1                  | 202      | 530 (Y) |
| 1752835† | 18     | 18    | 90    | 1                  | 228      | 530 (Y) |
| 1752836† | 18     | 18    | 96    | 1                  | 250      | 530 (Y) |

†Boxes can be used as topsiders and underbodies

## T-HANDLE LATCH

- 16 gauge steel box with 14 gauge steel doors
- Drop-down recessed doors
- Locking stainless steel T-handle latches
- Bolt-on continuous hidden hinge
- Replaceable gasket sealing system
- Aircraft grade door cables
- Optional quick-mount trays
- Includes J-hooks for drill-free mounting and protective side rail pads
- Door opening: flat surface mount (90°)



### Black



| Part No. | Height | Depth | Width | # Latches per Door | Wt. (lb) | Cat.    |
|----------|--------|-------|-------|--------------------|----------|---------|
| 1702940  | 16     | 13    | 72    | 1                  | 115      | 530 (Y) |
| 1702950  | 16     | 13    | 88    | 1                  | 120      | 530 (Y) |
| 1702960  | 16     | 13    | 96    | 2                  | 128      | 530 (Y) |
| 1702980  | 18     | 16    | 72    | 1                  | 118      | 530 (Y) |
| 1702990  | 18     | 16    | 88    | 1                  | 136      | 530 (Y) |
| 1703000  | 18     | 16    | 90    | 1                  | 150      | 530 (Y) |
| 1703020  | 18     | 16    | 96    | 2                  | 151      | 530 (Y) |

### Optional Trays

| Part No.    | Height | Depth | Width | Wt. (lb) | Cat.    |
|-------------|--------|-------|-------|----------|---------|
| 1702940TRAY | 2.25/4 | 10.75 | 35    | 11       | 530 (Y) |
| 1702950TRAY | 2.25/4 | 10.75 | 43    | 14       | 530 (Y) |
| 1702960TRAY | 2.25/4 | 10.75 | 47    | 15       | 530 (Y) |
| 1702980TRAY | 2.25/4 | 13.75 | 35    | 12       | 530 (Y) |
| 1702990TRAY | 2.25/4 | 13.75 | 43    | 14       | 530 (Y) |
| 1703000TRAY | 2.25/4 | 13.75 | 44    | 15       | 530 (Y) |
| 1703020TRAY | 2.25/4 | 13.75 | 77    | 16       | 530 (Y) |

### White



| Part No. | Height | Depth | Width | # Latches per Door | Wt. (lb) | Cat.    |
|----------|--------|-------|-------|--------------------|----------|---------|
| 1702840  | 16     | 13    | 72    | 1                  | 115      | 530 (Y) |
| 1702850  | 16     | 13    | 88    | 1                  | 120      | 530 (Y) |
| 1702860  | 16     | 13    | 96    | 2                  | 128      | 530 (Y) |
| 1702880  | 18     | 16    | 72    | 1                  | 118      | 530 (Y) |
| 1702890  | 18     | 16    | 88    | 1                  | 136      | 530 (Y) |
| 1702895  | 18     | 16    | 90    | 1                  | 136      | 530 (Y) |
| 1702920  | 18     | 16    | 96    | 2                  | 147      | 530 (Y) |

### Optional Trays

| Part No.    | Height | Depth | Width | Wt. (lb) | Cat.    |
|-------------|--------|-------|-------|----------|---------|
| 1702840TRAY | 2.25/4 | 10.75 | 35    | 11       | 530 (Y) |
| 1702850TRAY | 2.25/4 | 10.75 | 43    | 14       | 530 (Y) |
| 1702860TRAY | 2.25/4 | 10.75 | 47    | 15       | 530 (Y) |
| 1702880TRAY | 2.25/4 | 13.75 | 35    | 12       | 530 (Y) |
| 1702890TRAY | 2.25/4 | 13.75 | 43    | 14       | 530 (Y) |
| 1702895TRAY | 2.25/4 | 13.75 | 44    | 15       | 530 (Y) |
| 1702920TRAY | 2.25/4 | 13.75 | 77    | 16       | 530 (Y) |

# Aluminum Topsider

## FLIP UP DOOR WITH COMPRESSION LATCH

- Gas shocks hold door open at 110°
- .100" thick diamond tread aluminum
- Locking die-cast T-handle compression latch
- Full length stainless steel bolt-on continuous hidden hinge
- Recessed door design with large 13" tall opening
- Integrated above door rain gutter
- Reinforced door backbone
- Replaceable gasket sealing system



### Diamond Tread



| Part No. | Height | Depth | Width | # Latches per Door | Wt. (lb) | Cat.    |
|----------|--------|-------|-------|--------------------|----------|---------|
| 1701351* | 16     | 13    | 72    | 1                  | 78       | 530 (Y) |
| 1701356* | 16     | 13    | 88    | 1                  | 89       | 530 (Y) |
| 1701361* | 16     | 13    | 96    | 1                  | 92       | 530 (Y) |
| 1701363* | 18     | 16    | 72    | 1                  | 82       | 530 (Y) |
| 1701364* | 18     | 16    | 88    | 1                  | 92       | 530 (Y) |
| 1701365* | 18     | 16    | 90    | 1                  | 99       | 530 (Y) |
| 1701768  | 18     | 16    | 96    | 1                  | 103      | 530 (Y) |

### Black Diamond Tread



| Part No. | Height | Depth | Width | # Latches per Door | Wt. (lb) | Cat.    |
|----------|--------|-------|-------|--------------------|----------|---------|
| 1721351* | 16     | 13    | 72    | 1                  | 78       | 530 (Y) |
| 1721356* | 16     | 13    | 88    | 1                  | 89       | 530 (Y) |
| 1721361* | 16     | 13    | 96    | 1                  | 92       | 530 (Y) |
| 1721363* | 18     | 16    | 72    | 1                  | 82       | 530 (Y) |
| 1721364* | 18     | 16    | 88    | 1                  | 92       | 530 (Y) |
| 1721365* | 18     | 16    | 90    | 1                  | 99       | 530 (Y) |
| 1721768  | 18     | 16    | 96    | 1                  | 103      | 530 (Y) |

### Textured Matte Black Diamond Tread



| Part No. | Height | Depth | Width | # Latches per Door | Wt. (lb) | Cat.    |
|----------|--------|-------|-------|--------------------|----------|---------|
| 1722351* | 16     | 13    | 72    | 1                  | 78       | 530 (Y) |
| 1722356* | 16     | 13    | 88    | 1                  | 89       | 530 (Y) |
| 1722361* | 16     | 13    | 96    | 1                  | 92       | 530 (Y) |
| 1722363* | 18     | 16    | 72    | 1                  | 82       | 530 (Y) |
| 1722364* | 18     | 16    | 88    | 1                  | 92       | 530 (Y) |
| 1722365* | 18     | 16    | 90    | 1                  | 99       | 530 (Y) |
| 1722768  | 18     | 16    | 96    | 1                  | 103      | 530 (Y) |

\* **NEW** PRODUCTS



## DIAMOND TREAD DROP DOOR WITH COMPRESSION LATCH

- .100" thick diamond tread aluminum
- Locking die-cast T-handle compression latch
- Full length stainless steel bolt-on continuous hidden hinge
- Replaceable gasket sealing system
- Aircraft grade door cables
- Includes J-hooks for drill-free mounting and protective side rail pads
- Door opening: flat surface mount (90°)

### Diamond Tread, Single Latch



| Part No. | Height | Depth | Width | # Latches per Door | Wt. (lb) | Cat.    |
|----------|--------|-------|-------|--------------------|----------|---------|
| 1701551  | 16     | 13    | 72    | 1                  | 78       | 530 (Y) |
| 1701556  | 16     | 13    | 88    | 1                  | 89       | 530 (Y) |
| 1701563* | 18     | 16    | 72    | 1                  | 82       | 530 (Y) |
| 1701564* | 18     | 16    | 88    | 1                  | 92       | 530 (Y) |
| 1701565  | 18     | 16    | 90    | 1                  | 99       | 530 (Y) |

### Diamond Tread, Dual Latch

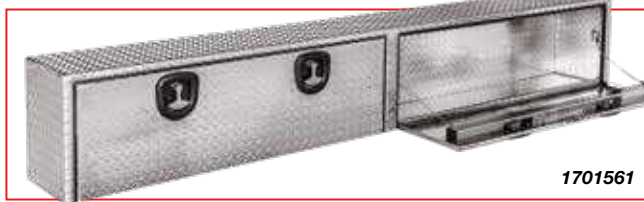

| Part No. | Height | Depth | Width | # Latches per Door | Wt. (lb) | Cat.    |
|----------|--------|-------|-------|--------------------|----------|---------|
| 1701561  | 16     | 13    | 96    | 2                  | 92       | 530 (Y) |
| 1701568  | 18     | 16    | 96    | 2                  | 103      | 530 (Y) |

### Black Diamond Tread, Single Latch



| Part No. | Height | Depth | Width | # Latches per Door | Wt. (lb) | Cat.    |
|----------|--------|-------|-------|--------------------|----------|---------|
| 1721551  | 16     | 13    | 72    | 1                  | 78       | 530 (Y) |
| 1721556  | 16     | 13    | 88    | 1                  | 89       | 530 (Y) |
| 1721563  | 18     | 16    | 72    | 1                  | 82       | 530 (Y) |
| 1721564  | 18     | 16    | 88    | 1                  | 92       | 530 (Y) |
| 1721565  | 18     | 16    | 90    | 1                  | 99       | 530 (Y) |

### Black Diamond Tread, Dual Latch



| Part No. | Height | Depth | Width | # Latches per Door | Wt. (lb) | Cat.    |
|----------|--------|-------|-------|--------------------|----------|---------|
| 1721561  | 16     | 13    | 96    | 2                  | 92       | 530 (Y) |
| 1721568  | 18     | 16    | 96    | 2                  | 103      | 530 (Y) |

### Textured Matte Black Diamond Tread, Single Latch



| Part No. | Height | Depth | Width | # Latches per Door | Wt. (lb) | Cat.    |
|----------|--------|-------|-------|--------------------|----------|---------|
| 1722551  | 16     | 13    | 72    | 1                  | 78       | 530 (Y) |
| 1722556  | 16     | 13    | 88    | 1                  | 89       | 530 (Y) |
| 1722563  | 18     | 16    | 72    | 1                  | 82       | 530 (Y) |
| 1722564  | 18     | 16    | 88    | 1                  | 92       | 530 (Y) |
| 1722565  | 18     | 16    | 90    | 1                  | 90       | 530 (Y) |

### Textured Matte Black Diamond Tread, Dual Latch



| Part No. | Height | Depth | Width | # Latches per Door | Wt. (lb) | Cat.    |
|----------|--------|-------|-------|--------------------|----------|---------|
| 1722561  | 16     | 13    | 96    | 2                  | 92       | 530 (Y) |
| 1722568  | 18     | 16    | 96    | 2                  | 103      | 530 (Y) |

# Aluminum Topsider

## SMOOTH ALUMINUM DROP DOOR WITH COMPRESSION LATCH

- .100" thick smooth aluminum
- Locking die-cast T-handle compression latch
- Full length stainless steel bolt-on continuous hidden hinge
- Replaceable gasket sealing system
- Aircraft grade door cables
- Includes J-hooks for drill-free mounting and protective side rail pads
- Door opening: flat surface mount (90°)

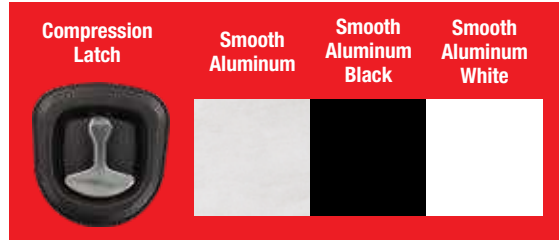

### Smooth Aluminum, Single Latch



| Part No. | Height | Depth | Width | # Latches per Door | Wt. (lb) | Cat.    |
|----------|--------|-------|-------|--------------------|----------|---------|
| 1751651  | 16     | 13    | 72    | 1                  | 78       | 530 (Y) |
| 1751656  | 16     | 13    | 88    | 1                  | 89       | 530 (Y) |
| 1751663  | 18     | 16    | 72    | 1                  | 93       | 530 (Y) |
| 1751664  | 18     | 16    | 88    | 1                  | 96       | 530 (Y) |
| 1751665  | 18     | 16    | 90    | 1                  | 99       | 530 (Y) |

### Smooth Aluminum, Dual Latch



| Part No. | Height | Depth | Width | # Latches per Door | Wt. (lb) | Cat.    |
|----------|--------|-------|-------|--------------------|----------|---------|
| 1751661  | 16     | 13    | 96    | 2                  | 92       | 530 (Y) |
| 1751668  | 18     | 16    | 96    | 2                  | 103      | 530 (Y) |

### Smooth Aluminum, Single Latch, Black



| Part No. | Height | Depth | Width | # Latches per Door | Wt. (lb) | Cat.    |
|----------|--------|-------|-------|--------------------|----------|---------|
| 1752151  | 16     | 13    | 72    | 1                  | 78       | 530 (Y) |
| 1752156  | 16     | 13    | 88    | 1                  | 89       | 530 (Y) |
| 1752163  | 18     | 16    | 72    | 1                  | 93       | 530 (Y) |
| 1752164  | 18     | 16    | 88    | 1                  | 96       | 530 (Y) |
| 1752165  | 18     | 16    | 90    | 1                  | 99       | 530 (Y) |

### Smooth Aluminum, Dual Latch, Black



| Part No. | Height | Depth | Width | # Latches per Door | Wt. (lb) | Cat.    |
|----------|--------|-------|-------|--------------------|----------|---------|
| 1752161  | 16     | 13    | 96    | 2                  | 92       | 530 (Y) |
| 1752168  | 18     | 16    | 96    | 2                  | 103      | 530 (Y) |

# Aluminum Topsider

## Smooth Aluminum, Single Latch, White



| Part No. | Height | Depth | Width | # Latches per Door | Wt. (lb) | Cat.    |
|----------|--------|-------|-------|--------------------|----------|---------|
| 1753151  | 16     | 13    | 72    | 1                  | 78       | 530 (Y) |
| 1753156  | 16     | 13    | 88    | 1                  | 89       | 530 (Y) |
| 1753163  | 18     | 16    | 72    | 1                  | 93       | 530 (Y) |
| 1753164  | 18     | 16    | 88    | 1                  | 96       | 530 (Y) |
| 1753165  | 18     | 16    | 90    | 1                  | 99       | 530 (Y) |

## Smooth Aluminum, Dual Latch, White



| Part No. | Height | Depth | Width | # Latches per Door | Wt. (lb) | Cat.    |
|----------|--------|-------|-------|--------------------|----------|---------|
| 1753161  | 16     | 13    | 96    | 2                  | 92       | 530 (Y) |
| 1753168  | 18     | 16    | 96    | 2                  | 103      | 530 (Y) |



# Aluminum Topsider

## CONTRACTOR WITH LOWER COMPARTMENT

- .056" thick diamond tread aluminum
- Gas shocks lift and open door at over 90 degree angle
- Comes with two doors: top flip-up door and bottom drop door
- Locking stainless steel T-handle latches
- Replaceable gasket sealing system
- Aircraft grade door cables
- Mounting hardware included



1705640 open

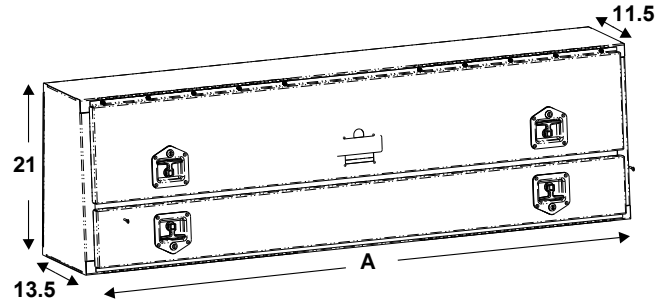

### Diamond Tread



1705640

| Part No. | Top Doors | Bottom Doors | Height | Depth     | Width (A) | Wt. (lb) | Cat.    |
|----------|-----------|--------------|--------|-----------|-----------|----------|---------|
| 1705640  | 1         | 1            | 21     | 13.5/11.5 | 72        | 69       | 530 (Y) |
| 1705650  | 1         | 1            | 21     | 13.5/11.5 | 88        | 84       | 530 (Y) |
| 1705660  | 1         | 1            | 21     | 13.5/11.5 | 96        | 89       | 530 (Y) |

Depth indicates bottom/top O.D.

### Black Diamond Tread



1725640

| Part No. | Top Doors | Bottom Doors | Height | Depth     | Width (A) | Wt. (lb) | Cat.    |
|----------|-----------|--------------|--------|-----------|-----------|----------|---------|
| 1725640  | 1         | 1            | 21     | 13.5/11.5 | 72        | 69       | 530 (Y) |
| 1725650  | 1         | 1            | 21     | 13.5/11.5 | 88        | 84       | 530 (Y) |
| 1725660  | 1         | 1            | 21     | 13.5/11.5 | 96        | 89       | 530 (Y) |

Depth indicates bottom/top O.D.

## CONTRACTOR WITH TWO LOWER DRAWERS

- .056" thick diamond tread aluminum
- Gas shocks lift and open door at over 90 degree angle
- Locking stainless steel T-handle latches
- Replaceable gasket sealing system
- Bottom drawers come with adjustable dividers and 100 lb rated 12" slides
- Mounting legs and hardware included

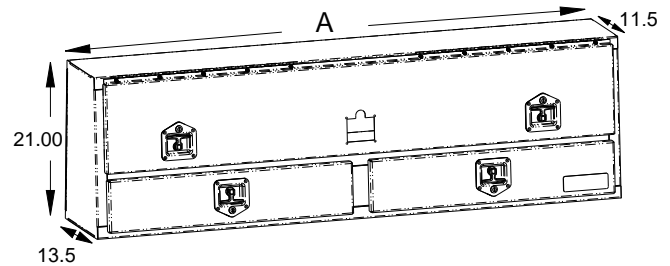

### Diamond Tread



| Part No. | Top Doors | Bottom Drawers | Height | Depth     | Width (A) | Wt. (lb) | Cat.    |
|----------|-----------|----------------|--------|-----------|-----------|----------|---------|
| 1705641  | 1         | 2              | 21     | 13.5/11.5 | 72        | 58       | 530 (Y) |
| 1705651  | 1         | 2              | 21     | 13.5/11.5 | 88        | 91       | 530 (Y) |

Depth indicates bottom/top O.D.

### Black Diamond Tread



| Part No. | Top Doors | Bottom Drawers | Height | Depth     | Width (A) | Wt. (lb) | Cat.    |
|----------|-----------|----------------|--------|-----------|-----------|----------|---------|
| 1725641  | 1         | 2              | 21     | 13.5/11.5 | 72        | 58       | 530 (Y) |
| 1725651  | 1         | 2              | 21     | 13.5/11.5 | 88        | 91       | 530 (Y) |

Depth indicates bottom/top O.D.

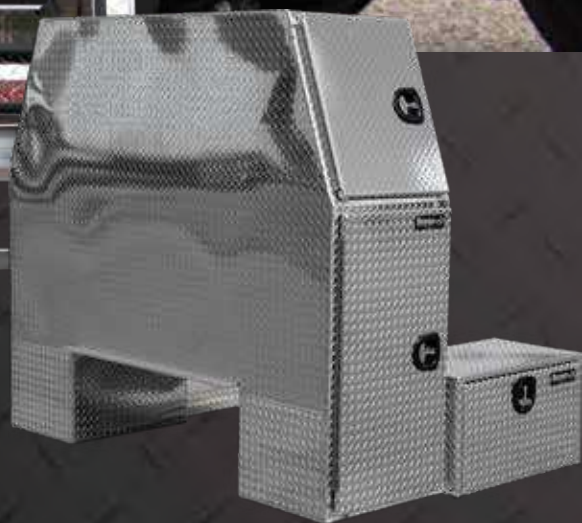

BAC

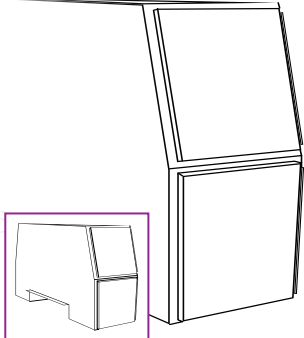
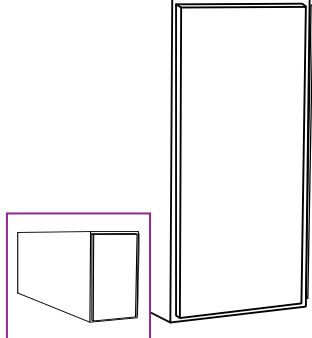
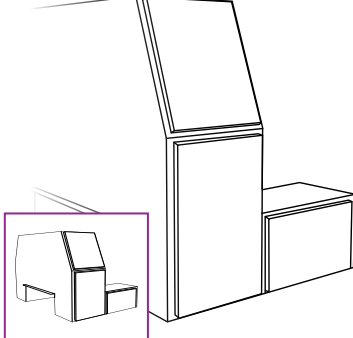

### Choose a style ...

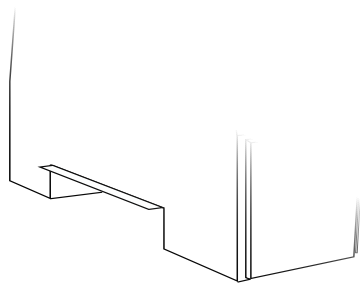
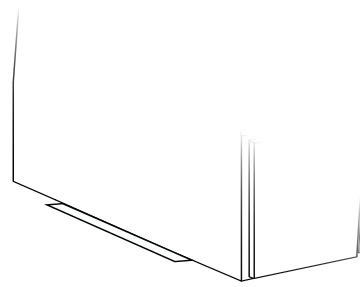

4 DOORS, SLANTED DOOR       2 DOORS, STRAIGHT SIDES       L-PACK

### Choose a floor ...

 **OFFSET FLOOR**  
(for conventional cabs)        **FLAT FLOOR**  
(for cab-over trucks)

### Choose a material ...

DIAMOND TREAD ALUMINUM       CARBON STEEL BLACK       CARBON STEEL WHITE       CARBON STEEL PRIMED

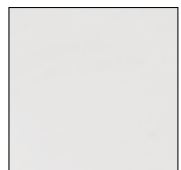
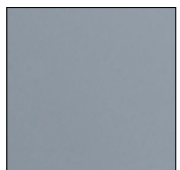
# CKPACK

# 4 Doors, Offset Floor

## DIAMOND TREAD ALUMINUM



- .100" thick aluminum diamond tread
- Universal spring cushion mounting kit, included with all aluminum backpack boxes, provides flex to reduce strain

## Common Features



Manufactured by a talented workforce in Northeast Ohio



Backpack mounting adapter recommended for all 2017+ Ford® applications (see page 65 for details)

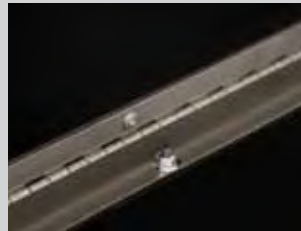

Stainless steel bolt-on continuous hidden hinges

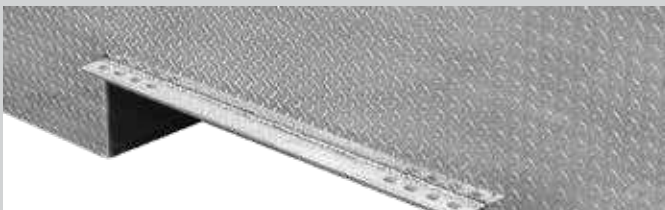

Integral mounting rail for quick and easy installation



Doors open easily with gas powered shocks plus built-in rain gutter with automotive bulb seal



Two shelves to organize tools and equipment plus two folding passenger side J-hooks



# 4 Doors, Offset Floor

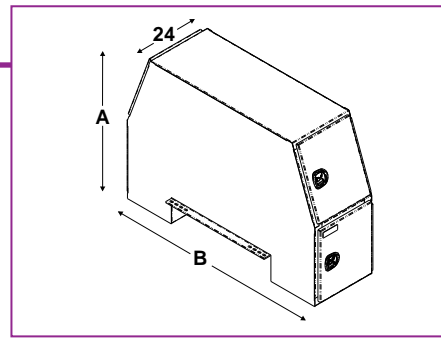

## Diamond Tread Aluminum

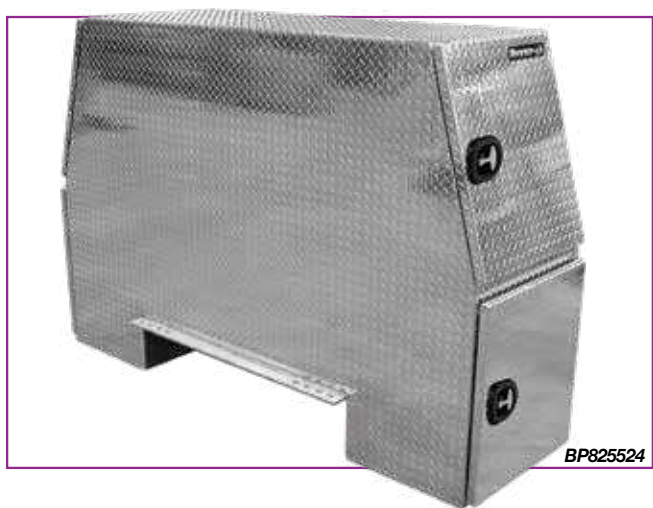

| Part No. | Total Height (A) | Depth | Width (B) | Wt. (lb) | Cat.    |
|----------|------------------|-------|-----------|----------|---------|
| BP825524 | 55               | 24    | 82        | 234      | 592 (Y) |
| BP826224 | 62               | 24    | 82        | 254      | 592 (Y) |
| BP826524 | 65               | 24    | 82        | 316      | 592 (Y) |
| BP827024 | 70               | 24    | 82        | 316      | 592 (Y) |
| BP925824 | 58               | 24    | 92        | 255      | 592 (Y) |



**\*\*CAUTION:** Failure to use supplied mounting kit may void warranty on Aluminum Backpack Boxes



# 4 Doors, Offset Floor

## CARBON STEEL



- 14 gauge steel box with 12 gauge steel doors
- Optional U-Bolt mounting kit sold separately (see page 64)

## Common Features



Manufactured by a talented workforce in Northeast Ohio



Backpack mounting adapter recommended for all 2017+ Ford® applications (see page 65 for details)



Stainless steel bolt-on continuous hidden hinges



Integral mounting rail for quick and easy installation



Doors open easily with gas powered shocks plus built-in rain gutter with automotive bulb seal



Two shelves to organize tools and equipment plus two folding passenger side J-hooks

# 4 Doors, Offset Floor

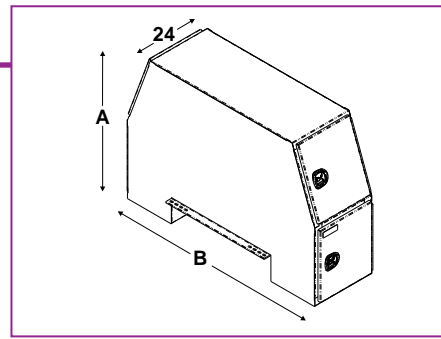

## Steel, Black Powder-Coated



| Part No.  | Total Height (A) | Depth | Width (B) | Wt. (lb) | Cat.    |
|-----------|------------------|-------|-----------|----------|---------|
| BP855524B | 55               | 24    | 85        | 536      | 592 (Y) |
| BP826524B | 65               | 24    | 82        | 600      | 592 (Y) |
| BP925824B | 58               | 24    | 92        | 576      | 592 (Y) |

 For optional underbody box, see pages 62-63.

## Steel, Black Powder-Coated Body, Polished Stainless Steel Doors



| Part No.      | Total Height (A) | Depth | Width (B) | Wt. (lb) | Cat.    |
|---------------|------------------|-------|-----------|----------|---------|
| BP855524BSST* | 55               | 24    | 85        | 538      | 592 (Y) |

 For optional underbody box, see pages 62-63.

## Steel, White Powder-Coated



| Part No.  | Total Height (A) | Depth | Width (B) | Wt. (lb) | Cat.    |
|-----------|------------------|-------|-----------|----------|---------|
| BP855524W | 55               | 24    | 85        | 538      | 592 (Y) |
| BP826524W | 65               | 24    | 82        | 600      | 592 (Y) |
| BP925824W | 58               | 24    | 92        | 576      | 592 (Y) |

 For optional underbody box, see pages 62-63.

## Steel, Primed Powder-Coated



| Part No.  | Total Height (A) | Depth | Width (B) | Wt. (lb) | Cat.    |
|-----------|------------------|-------|-----------|----------|---------|
| BP855524P | 55               | 24    | 85        | 538      | 592 (Y) |
| BP826524P | 65               | 24    | 82        | 538      | 592 (Y) |
| BP925824P | 58               | 24    | 92        | 576      | 592 (Y) |

 For optional underbody box, see pages 62-63.

\* **NEW** PRODUCTS

# 4 Doors, Flat Floor

## DIAMOND TREAD ALUMINUM



- .100" thick aluminum diamond tread
- Universal spring cushion mounting kit, included with all aluminum backpack boxes, provides flex to reduce strain

## Common Features



Manufactured by a talented workforce in Northeast Ohio



Backpack mounting adapter recommended for all 2017+ Ford® applications (see page 65 for details)

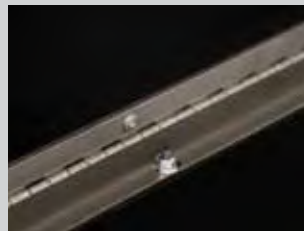

Stainless steel bolt-on continuous hidden hinges

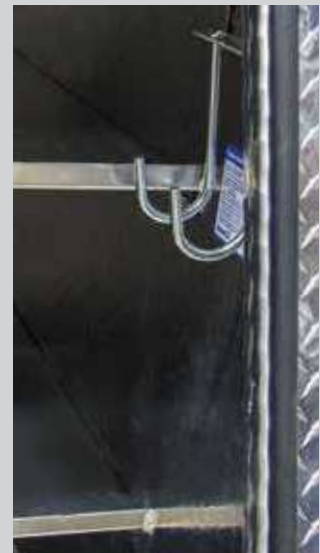

Two shelves to organize tools and equipment plus two folding passenger side J-hooks



Integral mounting rail for quick and easy installation



Doors open easily with gas powered shocks plus built-in rain gutter with automotive bulb seal

# 4 Doors, Flat Floor

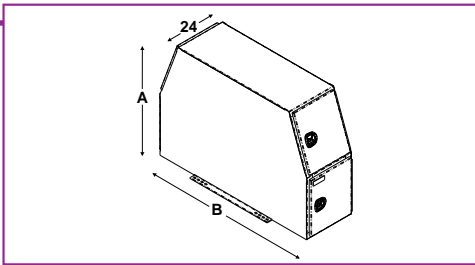

|   |  |   |
|---|--|---|
| <b>Compression Latch</b><br> | <b>Diamond Tread</b><br> | <b>Spring Cushion Mounting Kit**</b><br> |
|---|--|---|

## Diamond Tread Aluminum



| Part No. | Total Height (A) | Depth | Width (B) | Wt. (lb) | Cat.    |
|----------|------------------|-------|-----------|----------|---------|
| BP824624 | 46               | 24    | 82        | 216      | 592 (Y) |
| BP855924 | 59               | 24    | 85        | 350      | 530 (Y) |

**For optional underbody box, see pages 62-63.**

**⚠️\*\*CAUTION:** Failure to use supplied mounting kit may void warranty on Aluminum Backpack Boxes



# 4 Doors, Flat Floor

## CARBON STEEL



- 14 gauge steel box with 12 gauge steel doors
- Optional U-Bolt mounting kit sold separately (see page 64)

## Common Features



Manufactured by a talented workforce in Northeast Ohio



Backpack mounting adapter recommended for all 2017+ Ford® applications (see page 65 for details)

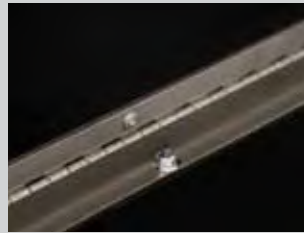

Stainless steel bolt-on continuous hidden hinges



Integral mounting rail for quick and easy installation



Doors open easily with gas powered shocks plus built-in rain gutter with automotive bulb seal



Two shelves to organize tools and equipment plus two folding passenger side J-hooks

# 4 Doors, Flat Floor

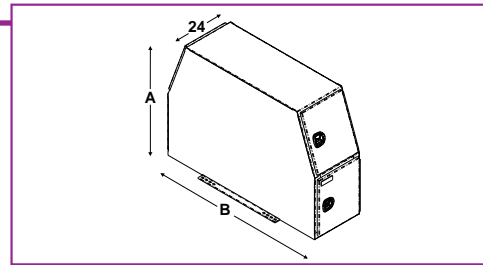

## Steel, Black Powder-Coated



| Part No.  | Total Height (A) | Depth | Width (B) | Wt. (lb) | Cat.    |
|-----------|------------------|-------|-----------|----------|---------|
| BP824624B | 46               | 24    | 82        | 454      | 592 (Y) |
| BP855924B | 59               | 85    | 536       | 592 (Y)  |         |

For optional underbody box, see pages 62-63.

## Steel, Black Powder-Coated Body, Polished Stainless Steel Doors



| Part No.      | Total Height (A) | Depth | Width (B) | Wt. (lb) | Cat.    |
|---------------|------------------|-------|-----------|----------|---------|
| BP855924BSST* | 59               | 24    | 85        | 536      | 592 (Y) |

For optional underbody box, see pages 62-63.

## Steel, White Powder-Coated



| Part No.  | Total Height (A) | Depth | Width (B) | Wt. (lb) | Cat.    |
|-----------|------------------|-------|-----------|----------|---------|
| BP824624W | 46               | 24    | 81        | 454      | 592 (Y) |
| BP855924W | 59               | 24    | 85        | 536      | 592 (Y) |

For optional underbody box, see pages 62-63.

## Steel, Primed Powder-Coated



| Part No.  | Total Height (A) | Depth | Width (B) | Wt. (lb) | Cat.    |
|-----------|------------------|-------|-----------|----------|---------|
| BP824624P | 46               | 24    | 81        | 454      | 592 (Y) |
| BP855924P | 59               | 24    | 85        | 536      | 592 (Y) |

For optional underbody box, see pages 62-63.

\* **NEW** PRODUCTS

# 2 Doors, Offset Floor

## DIAMOND TREAD ALUMINUM



- .100" thick aluminum diamond tread
- Universal spring cushion mounting kit, included with all aluminum backpack boxes, provides flex to reduce strain

## CARBON STEEL



- 14 gauge steel box with 12 gauge steel doors
- Optional U-Bolt mounting kit sold separately (see page 64)

## Common Features



Manufactured by a talented workforce in Northeast Ohio



Backpack mounting adapter recommended for all 2017+ Ford® applications (see page 65 for details)

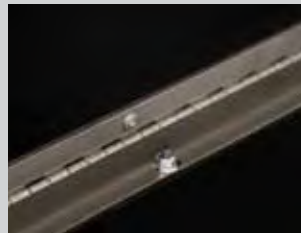

Stainless steel bolt-on continuous hidden hinges

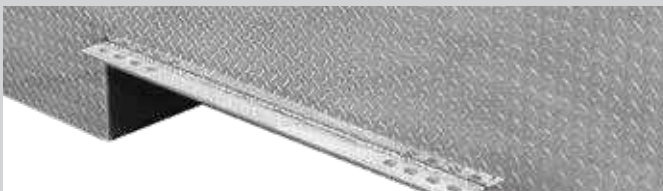

Integral mounting rail for quick and easy installation



Doors open easily with gas powered shocks plus built-in rain gutter with automotive bulb seal



Two shelves to organize tools and equipment plus two folding passenger side J-hooks



## Diamond Tread Aluminum



BP965724

**⚠️ CAUTION:** Failure to use supplied mounting kit may void warranty on Aluminum Backpack Boxes



| Part No. | Total Height | Depth | Width | Wt. (lb) | Cat.    |
|----------|--------------|-------|-------|----------|---------|
| BP965724 | 57           | 24    | 96    | 262      | 592 (Y) |



For optional underbody box, see pages 62-63.

## Steel, Black Powder-Coated



BP965724B



| Part No.  | Total Height | Depth | Width | Wt. (lb) | Cat.    |
|-----------|--------------|-------|-------|----------|---------|
| BP965724B | 57           | 24    | 96    | 690      | 592 (Y) |



For optional underbody box, see pages 62-63.

## Steel, White Powder-Coated



BP965724W

| Part No.  | Total Height | Depth | Width | Wt. (lb) | Cat.    |
|-----------|--------------|-------|-------|----------|---------|
| BP965724W | 57           | 24    | 96    | 690      | 592 (Y) |



For optional underbody box, see pages 62-63.

# 2 Doors, Flat Floor

## DIAMOND TREAD ALUMINUM



- .100" thick aluminum diamond tread
- Universal spring cushion mounting kit, included with all aluminum backpack boxes, provides flex to reduce strain

## CARBON STEEL



- 14 gauge steel box with 12 gauge steel doors
- Optional U-Bolt mounting kit sold separately (see page 64)

## Common Features



Manufactured by a talented workforce in Northeast Ohio



Backpack mounting adapter recommended for all 2017+ Ford® applications (see page 65 for details)

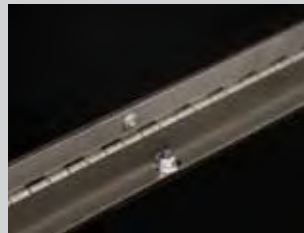

Stainless steel bolt-on continuous hidden hinges



Integral mounting rail for quick and easy installation



Doors open easily with gas powered shocks plus built-in rain gutter with automotive bulb seal

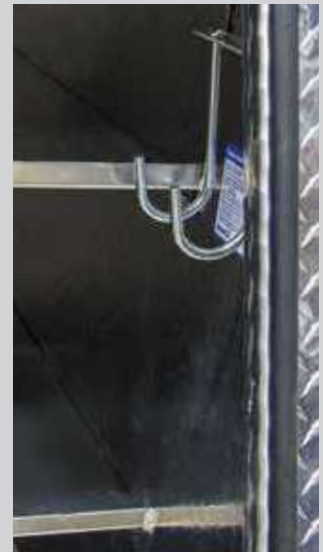

Two shelves to organize tools and equipment plus two folding passenger side J-hooks

## Diamond Tread Aluminum



BP964824

**CAUTION:** Failure to use supplied mounting kit may void warranty on Aluminum Backpack Boxes



| Part No. | Total Height | Depth | Width | Wt. (lb) | Cat.    |
|----------|--------------|-------|-------|----------|---------|
| BP964824 | 48           | 24    | 96    | 240      | 592 (Y) |



For optional underbody box, see pages 62-63.

## Steel, Black Powder-Coated



BP964824B



| Part No.    | Total Height | Depth | Width | Wt. (lb) | Cat.    |
|-------------|--------------|-------|-------|----------|---------|
| BP964824B   | 48           | 24    | 96    | 700      | 592 (Y) |
| BP964824BLL | 48           | 24    | 96    | 700      | 592 (Y) |

BP964824BLL comes with 2 full length adjustable shelves



For optional underbody box, see pages 62-63.

## Steel, White Powder-Coated



BP964824W

| Part No.    | Total Height | Depth | Width | Wt. (lb) | Cat.    |
|-------------|--------------|-------|-------|----------|---------|
| BP964824W   | 48           | 24    | 96    | 700      | 592 (Y) |
| BP964824WLL | 48           | 24    | 96    | 700      | 592 (Y) |

BP964824WLL comes with 2 full length adjustable shelves



For optional underbody box, see pages 62-63.

## Steel, Primed Powder-Coated



BP964824P

| Part No.  | Total Height | Depth | Width | Wt. (lb) | Cat.    |
|-----------|--------------|-------|-------|----------|---------|
| BP964824P | 48           | 24    | 96    | 700      | 592 (Y) |



For optional underbody box, see pages 62-63.

# L-Pack

## DIAMOND TREAD ALUMINUM

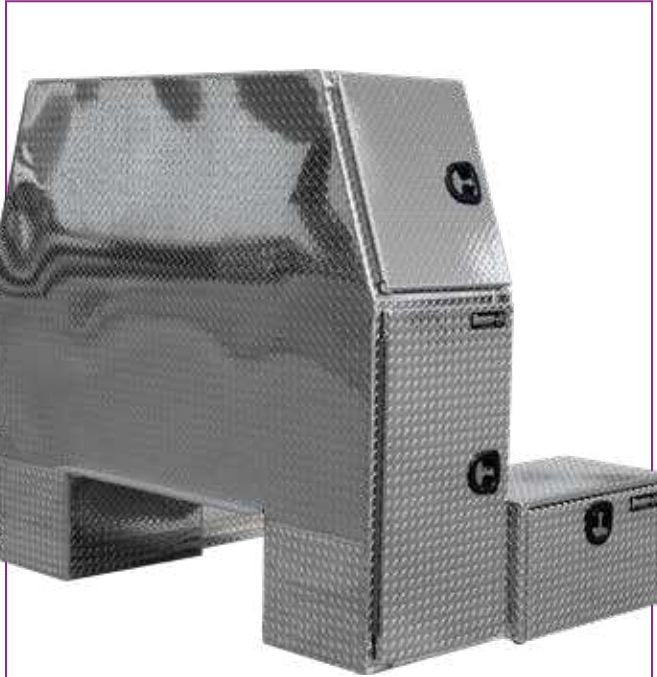

- .100" thick aluminum diamond tread
- Ships with 2 additional 30" underbody boxes welded on to provide additional storage
- Universal spring cushion mounting kit, included with all aluminum backpack boxes, provides flex to reduce strain

## CARBON STEEL



- Tough 14 gauge steel body and 12 gauge steel doors with a corrosion resistant powder-coated finish
- Ships with 2 additional 24" underbody boxes bolted on to provide additional storage
- Optional U-Bolt mounting kit sold separately (see page 64)

## Common Features



Manufactured by a talented workforce in Northeast Ohio



Backpack mounting adapter recommended for all 2017+ Ford® applications (see page 65 for details)



Stainless steel bolt-on continuous hidden hinges

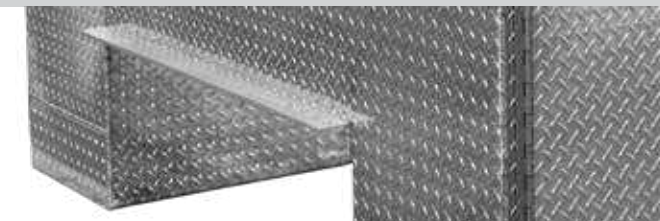

Integral mounting rail for quick and easy installation



Doors open easily with gas powered shocks plus built-in rain gutter with automotive bulb seal



Two shelves to organize tools and equipment plus two folding passenger side J-hooks

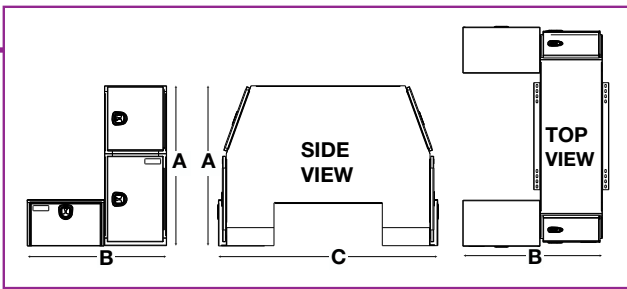

## Diamond Tread Aluminum

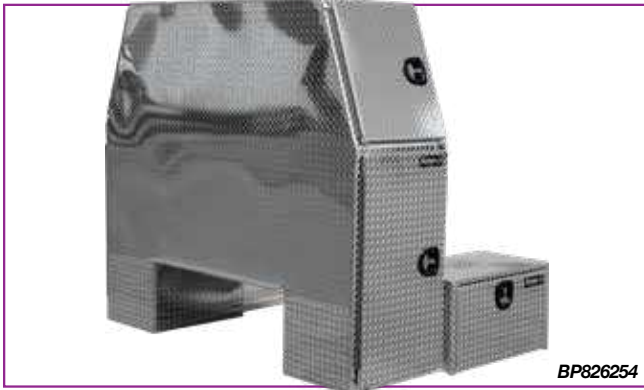

| Part No. | Total Height (A) | Depth (C) | Width (B) | Wt. (lb) | Cat.    |
|----------|------------------|-----------|-----------|----------|---------|
| BP826254 | 62               | 54        | 82        | 340      | 592 (Y) |
| BP827054 | 70               | 54        | 82        | 384      | 592 (Y) |

**\*\*CAUTION:** Failure to use supplied mounting kit may void warranty on Aluminum Backpack Boxes

## Steel, Black Powder-Coated



| Part No.  | Total Height (A) | Depth (C) | Width (B) | Wt. (lb) | Cat.    |
|-----------|------------------|-----------|-----------|----------|---------|
| BP855548B | 55               | 54        | 82        | 638      | 592 (Y) |

## Steel, White Powder-Coated



| Part No.  | Total Height (A) | Depth (C) | Width (B) | Wt. (lb) | Cat.    |
|-----------|------------------|-----------|-----------|----------|---------|
| BP855548W | 55               | 54        | 82        | 638      | 592 (Y) |

# Underbody Boxes for Backpacks

## DIAMOND TREAD ALUMINUM



- Can be used as bolt-on or weld-on underbodies with any backpack box
- Durable, corrosion-resistant, .100" thick aluminum diamond tread
- Locking die-cast T-handle compression latch

## CARBON STEEL



- Can be used as bolt-on underbodies with any backpack box
- 14 gauge powder-coated steel box with 12 gauge steel door
- Locking stainless steel T-handle latch

## Common Features



Manufactured by a talented workforce in Northeast Ohio



Drop-down recessed door



Aluminum bolt-on continuous hidden hinge and replaceable gasket sealing system

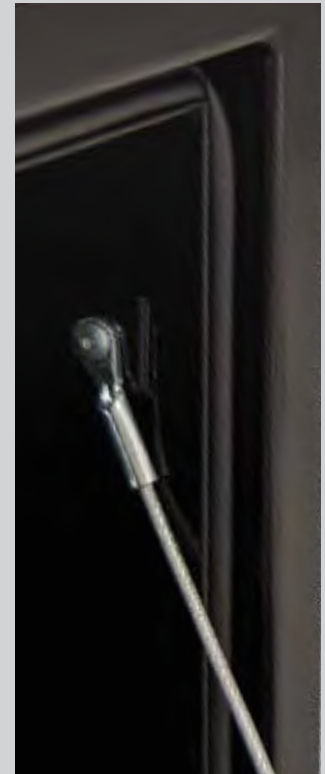

Aircraft grade door cables

# Underbody Boxes for Backpacks

## Diamond Tread Aluminum



| Part No. | Height | Depth | Width | Wt. (lb) | Cat. |
|----------|--------|-------|-------|----------|------|
| BP141624 | 14     | 16    | 24    | 18       | 530  |

## Steel, Black Powder-Coated



| Part No. | Height | Depth | Width | Wt. (lb) | Cat. |
|----------|--------|-------|-------|----------|------|
| 1703300  | 14     | 16    | 25    | 46       | 530  |
| 1703303  | 14     | 16    | 30    | 55       | 530  |
| 1703304* | 14     | 16    | 30    | 72       | 530  |

\*Includes built-in shelf

## Steel, White Powder-Coated



| Part No. | Height | Depth | Width | Wt. (lb) | Cat. |
|----------|--------|-------|-------|----------|------|
| 1703400  | 14     | 16    | 24    | 46       | 530  |
| 1703403  | 14     | 16    | 30    | 55       | 530  |
| 1703404* | 14     | 16    | 30    | 72       | 530  |

\*Includes built-in shelf

## Steel, Primed Powder-Coated



| Part No. | Height | Depth | Width | Wt. (lb) | Cat. |
|----------|--------|-------|-------|----------|------|
| 1703900  | 14     | 16    | 24    | 46       | 530  |

# Accessories

## STEEL AND ALUMINUM BACKPACK ACCESSORIES



### Universal Spring Cushion Mounting Kit

- Provides flex to reduce strain on steel and aluminum backpack truck boxes
- Ideal for off-road applications
- 5/8" U-bolts with forged tie bars, springs and fasteners (all zinc plated)
- Included with all aluminum backpacks
- ⚠ **CAUTION:** Failure to use supplied mounting kit may void warranty on aluminum backpack boxes
- Additional sizes available as custom orders



| Part No. | Description                           | Wt. (lb) | Cat.    |
|----------|---------------------------------------|----------|---------|
| 3008086  | Universal Spring Cushion Mounting Kit | 17       | 531 (Y) |

### Universal Square Bend U-Bolt Kit

- Secure truck boxes to truck body, or connect body to truck chassis
- 5/8" U-Bolts with fasteners and forged tie bars
- Durable Grade 5 hardware
- Additional sizes available as custom orders

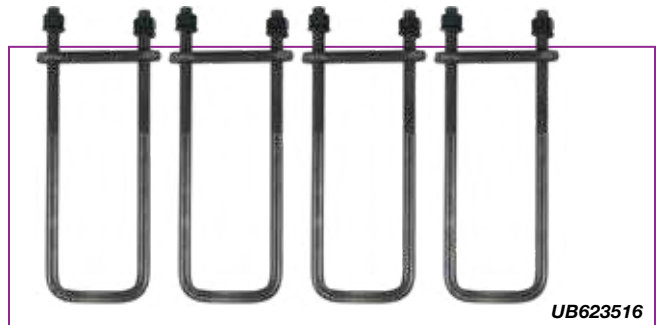

| Part No. | Description            | Wt. (lb) | Cat.    |
|----------|------------------------|----------|---------|
| UB623516 | Universal Mounting Kit | 17       | 531 (Y) |



## Backpack Mounting Adapter

- Provides a level base with a pre-fabricated kit that ensures optimal fit and reduced installation time
- Black powder-coated bracket and zinc plated hardware add corrosion resistance
- Recommended for use with all Ford® 2017+ applications

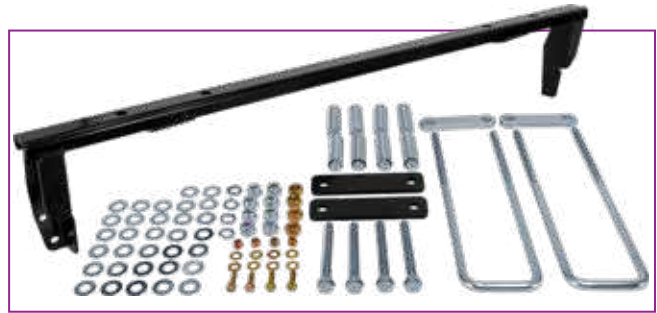

| Part No.        | Description                                 | Wt. (lb) | Cat.    |
|-----------------|---|----------|---------|
| <b>3037014</b>  | For Ford F350, F450, F550 (2017 - Mid 2020) | 47.24    | 531 (Y) |
| <b>3037014A</b> | For Ford F350, F450, F550 (2020+)           | 46.96    | 531 (Y) |

## J-Hook Hanger

- Universal J-hook hangers for holding items like chains or straps
  - Bolt-on or weld-on
  - Folding zinc plated J-hooks swing flush with compartment walls when not in use
  - Hanger 3009122 comes installed inside every box\*
- \*Excludes BP964824BLL and BP964824WLL due to full-length shelving.

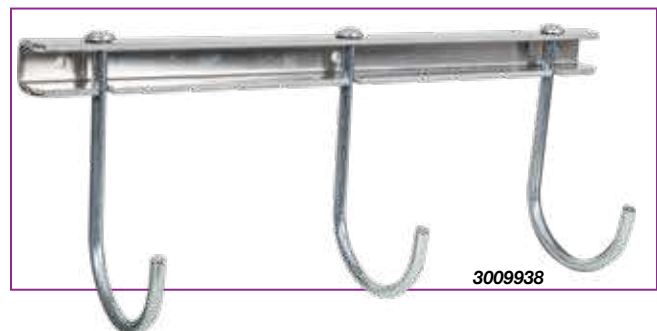

| Part No.       | Description                                | Wt. (lb) | Cat.      |
|----------------|--|----------|-----------|
| <b>3009122</b> | Double J-Hook with Steel Mounting Angle    | 0.85     | 530-1 (N) |
| <b>3009938</b> | Triple J-Hook with Aluminum Mounting Angle | 2.16     | 530-1 (N) |

# Accessories

## Silicone LED Strip Lights With 3M™ Adhesive Back

- Flexible strip lights can be mounted nearly anywhere extra light is needed. Ideal for tool boxes, truck beds, storage boxes, and trunk areas
- Each strip has a blunt cut connection on both ends and can be cut to length every three LEDs
- IP67 rated for water and dust resistance and backed with a 5 year warranty
- Includes end caps and mounting clips
- Separate 17.5" mounting channel also available



|                   |                             |
|-------------------|-----------------------------|
| Connection        | Blunt Cut, Both Ends        |
| Hardware Included | End Caps and Mounting Clips |

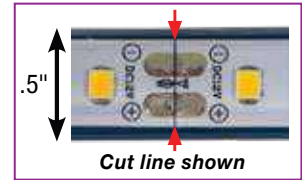

### Clear Warm Strip Lights

| Part No. | Size | LED's | Amps | Lumens | Wt. (lbs.) | Cat.    |
|----------|------|-------|------|--------|------------|---------|
| 5622029  | 18"  | 27    | 0.45 | 486    | 0.31       | 562 (N) |
| 5622840  | 24"  | 36    | 0.60 | 648    | 0.35       | 562 (N) |
| 5623856  | 36"  | 54    | 0.90 | 972    | 0.40       | 562 (N) |
| 5625276  | 48"  | 72    | 1.20 | 1,296  | 0.44       | 562 (N) |



### Clear Cool Strip Lights

| Part No. | Size | LED's | Amps | Lumens | Wt. (lbs.) | Cat.    |
|----------|------|-------|------|--------|------------|---------|
| 5622120  | 18"  | 27    | 0.45 | 513    | 0.31       | 562 (N) |
| 5622941  | 24"  | 36    | 0.60 | 684    | 0.35       | 562 (N) |
| 5623957  | 36"  | 54    | 0.90 | 1,026  | 0.40       | 562 (N) |
| 5625377  | 48"  | 72    | 1.20 | 1,368  | 0.44       | 562 (N) |



## LED Strip Lights With 3M™ Adhesive Back



|                   |                             |
|-------------------|-----------------------------|
| Connection        | Blunt Cut, Both Ends        |
| Hardware Included | End Caps and Mounting Clips |

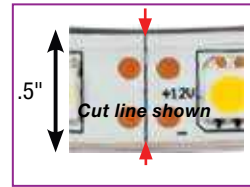

### Clear Warm Strip Lights

| Part No. | Size | LED's | Amps | Lumens | Wt. (lbs.) | Cat.    |
|----------|------|-------|------|--------|------------|---------|
| 5621827  | 18"  | 27    | 0.41 | 360    | 0.31       | 562 (N) |
| 5622436  | 24"  | 36    | 0.54 | 470    | 0.35       | 562 (N) |
| 5623654  | 36"  | 54    | 0.81 | 710    | 0.40       | 562 (N) |
| 5624872  | 48"  | 72    | 1.12 | 940    | 0.44       | 562 (N) |
| 5626090  | 60"  | 90    | 1.30 | 1,180  | 0.55       | 562 (N) |
| 56296144 | 96"  | 144   | 2.00 | 2,160  | 0.88       | 562 (N) |



### Clear Cool Strip Lights

| Part No.  | Size | LED's | Amps | Lumens | Wt. (lbs.) | Cat.    |
|-----------|------|-------|------|--------|------------|---------|
| 5621928   | 18"  | 27    | 0.41 | 360    | 0.31       | 562 (N) |
| 5622537   | 24"  | 36    | 0.54 | 470    | 0.35       | 562 (N) |
| 5623755   | 36"  | 54    | 0.81 | 710    | 0.40       | 562 (N) |
| 5624973   | 48"  | 72    | 1.12 | 940    | 0.44       | 562 (N) |
| 5626191   | 60"  | 90    | 1.30 | 1,175  | 0.55       | 562 (N) |
| 56297145  | 96"  | 144   | 2.00 | 2,160  | 0.88       | 562 (N) |
| 562109166 | 108" | 165   | 3.00 | 2,400  | 1.12       | 562 (N) |
| 562133202 | 132" | 201   | 4.00 | 3,000  | 1.37       | 562 (N) |



### Accessories

| Part No. | Description  | Wt. (lbs.) | Cat.    |
|----------|--|------------|---------|
| 3035896  | LED Strip Light Mounting Channel, 17-1/2" Long, Black, Mounting 3M® Tape | 0.39       | 562 (N) |



### Accessories

| Part No. | Description   | Wt. (lbs.) | Cat.    |
|----------|---|------------|---------|
| 5621002  | LED Strobe Controller with 6" Leads Converts Steady-On Strip Lights to a Strobe Pattern | 0.07       | 562 (N) |



# TUNNEL



# L BOXES

# Tunnel Boxes

**ALL NEW**

## DIAMOND TREAD ALUMINUM



- .100" thick aluminum diamond tread

## CARBON STEEL



- 15 gauge steel box with 12 gauge steel doors

## Common Features



Manufactured by a talented workforce in Northeast Ohio



1/4 in. stainless steel continuous hinges



Rain channel and watertight automotive bulb seal keeps tools protected



Full length stationary shelf provides organization for tools and equipment.

## Diamond Tread Aluminum

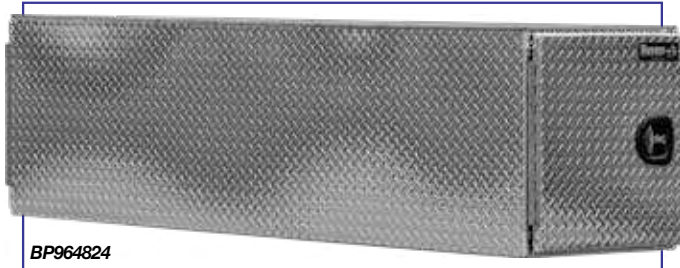

BP964824

| Part No.  | Height | Depth | Width | Wt. (lb) | Cat.    |
|-----------|--------|-------|-------|----------|---------|
| BP242486* | 24     | 24    | 86    | 125      | 592 (Y) |
| BP242496* | 24     | 24    | 96    | 135      | 592 (Y) |

## Steel, Black Powder-Coated

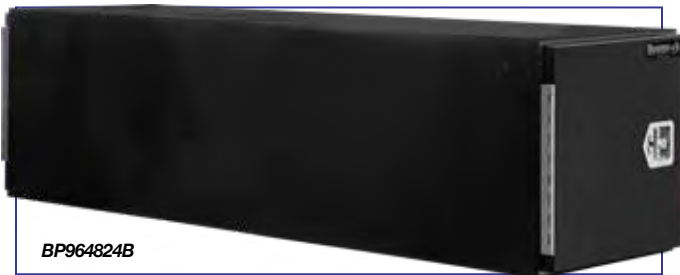

BP964824B

| Part No.   | Height | Depth | Width | Wt. (lb) | Cat.    |
|------------|--------|-------|-------|----------|---------|
| BP242486B* | 24     | 24    | 86    | 245      | 592 (Y) |
| BP242496B* | 24     | 24    | 96    | 265      | 592 (Y) |

## Steel, White Powder-Coated



BP964824W

| Part No.   | Height | Depth | Width | Wt. (lb) | Cat.    |
|------------|--------|-------|-------|----------|---------|
| BP242486W* | 24     | 24    | 86    | 245      | 592 (Y) |
| BP242496W* | 24     | 24    | 96    | 265      | 592 (Y) |



# IN-BED S





# STORAGE

# Crossover Truck Boxes

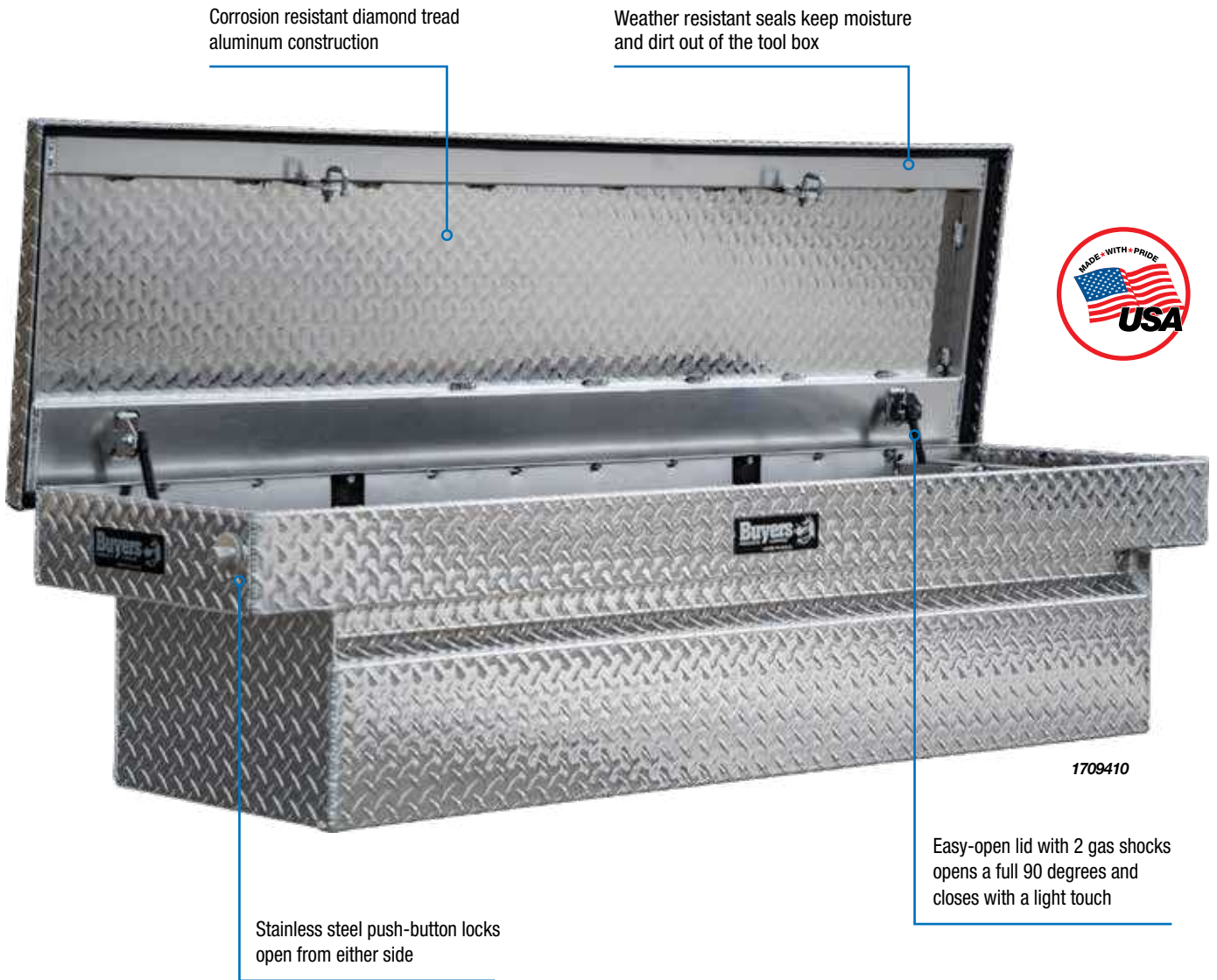

Corrosion resistant diamond tread aluminum construction

Weather resistant seals keep moisture and dirt out of the tool box



1709410

Stainless steel push-button locks open from either side

Easy-open lid with 2 gas shocks opens a full 90 degrees and closes with a light touch

## Crossover Features



Lockable tray and integrated tool holders make it easy to stay organized



Stainless steel push-button locks



Fully concealed aluminum continuous hinge

## SINGLE LID WITH PUSH-BUTTON LOCK

- Available for full-size and compact pickups
- Gas shock props lid open
- Stainless steel push-button locks open from either side
- Suspends from pickup side rails
- Includes mounting hardware
- Locking tool tray with removable dividers
- Pre-drilled mounting holes and included hardware make installation easy

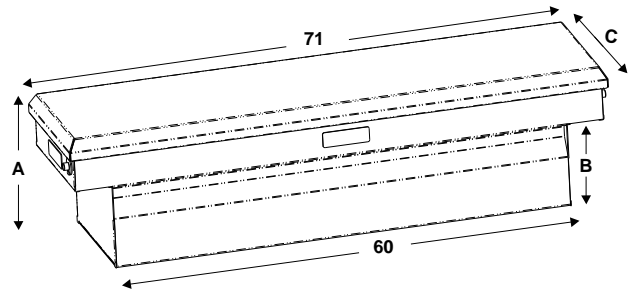
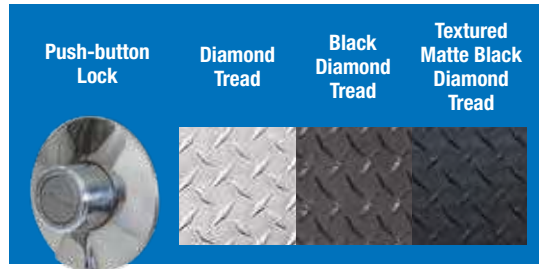

### Diamond Tread



| Part No. | Height (A/B) | Depth (C) | Width | Wt. (lb) | Cat.    |
|----------|--------------|-----------|-------|----------|---------|
| 1709410  | 18/11        | 20        | 71/60 | 75       | 530 (Y) |
| 1709415  | 23/16        | 20        | 71/60 | 81       | 530 (Y) |
| 1709420  | 18/11        | 27        | 71/60 | 89       | 530 (Y) |
| 1709425  | 23/16        | 27        | 71/60 | 94       | 530 (Y) |
| 1709430  | 13/6         | 20        | 63/54 | 63       | 530 (Y) |

### Black Diamond Tread



| Part No. | Height (A/B) | Depth (C) | Width | Wt. (lb) | Cat.    |
|----------|--------------|-----------|-------|----------|---------|
| 1729410  | 18/11        | 20        | 71/60 | 75       | 530 (Y) |
| 1729415  | 23/16        | 20        | 71/60 | 77       | 530 (Y) |
| 1729420  | 18/11        | 27        | 71/60 | 89       | 530 (Y) |
| 1729425  | 23/16        | 27        | 71/60 | 91       | 530 (Y) |
| 1729430  | 13/6         | 20        | 63/54 | 63       | 530 (Y) |

### Textured Matte Black Diamond Tread



| Part No. | Height (A/B) | Depth (C) | Width | Wt. (lb) | Cat.    |
|----------|--------------|-----------|-------|----------|---------|
| 1739410  | 18/11        | 20        | 71/60 | 75       | 530 (Y) |
| 1739420  | 18/11        | 27        | 71/60 | 89       | 530 (Y) |
| 1739415  | 23/16        | 20        | 71/60 | 81       | 530 (Y) |
| 1739425  | 23/16        | 27        | 71/60 | 94       | 530 (Y) |
| 1739430  | 13/6         | 20        | 63/54 | 63       | 530 (Y) |

# Gull Wing Truck Boxes

## NEW DESIGN

Weather resistant seals keep moisture and dirt out of the tool box

Corrosion resistant diamond tread aluminum construction



Stainless steel push-button locks open from either side

Easy-open lids with 2 gas shocks opens and closes with a light touch

1709410

## Gull Wing Features



Tools and equipment stay organized with included tray and dividers.



Stainless steel push-button locks



Fully concealed aluminum continuous hinge

## GULL WING WITH PUSH-BUTTON LOCK

- Available for full-size pickups
- Gas shock props lid open
- Stainless steel push-button locks open from either side
- Suspends from pickup side rails
- Includes mounting hardware
- Locking tool tray with removable dividers
- Pre-drilled mounting holes and included hardware make installation easy

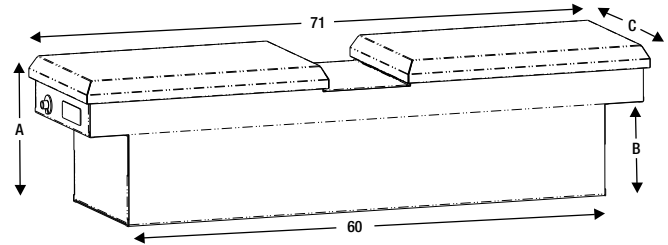
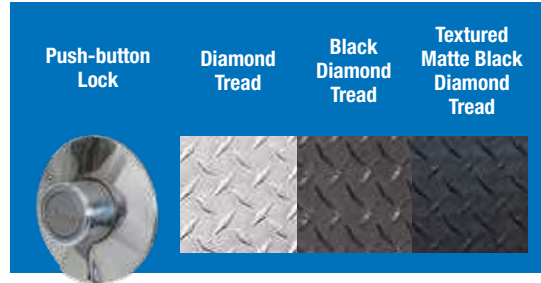

### Diamond Tread



1710410

| Part No. | Height (A/B) | Depth (C) | Width | Wt. (lb) | Cat.    |
|----------|--------------|-----------|-------|----------|---------|
| 1710410* | 18/11        | 20        | 71/60 | 77       | 530 (Y) |
| 1710413* | 23/16        | 20        | 71/60 | 83       | 530 (Y) |
| 1710420* | 18/11        | 27        | 71/60 | 93       | 530 (Y) |
| 1710423* | 23/16        | 27        | 71/60 | 100      | 530 (Y) |

### Black Diamond Tread



1720410

| Part No. | Height (A/B) | Depth (C) | Width | Wt. (lb) | Cat.    |
|----------|--------------|-----------|-------|----------|---------|
| 1720410* | 18/11        | 20        | 71/60 | 77       | 530 (Y) |
| 1720413* | 23/16        | 20        | 71/60 | 83       | 530 (Y) |
| 1720420* | 18/11        | 27        | 71/60 | 93       | 530 (Y) |
| 1720423* | 23/16        | 27        | 71/60 | 100      | 530 (Y) |

### Textured Matte Black Diamond Tread

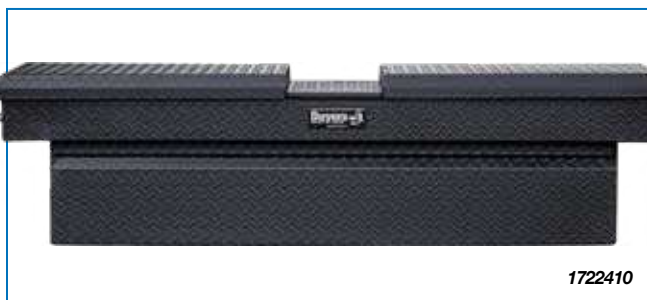

1722410

| Part No. | Height (A/B) | Depth (C) | Width | Wt. (lb) | Cat.    |
|----------|--------------|-----------|-------|----------|---------|
| 1722410* | 18/11        | 20        | 71/60 | 77       | 530 (Y) |
| 1722413* | 23/16        | 20        | 71/60 | 83       | 530 (Y) |
| 1722420* | 18/11        | 27        | 71/60 | 93       | 530 (Y) |
| 1722423* | 23/16        | 27        | 71/60 | 100      | 530 (Y) |

# Lo-Sider Truck Boxes

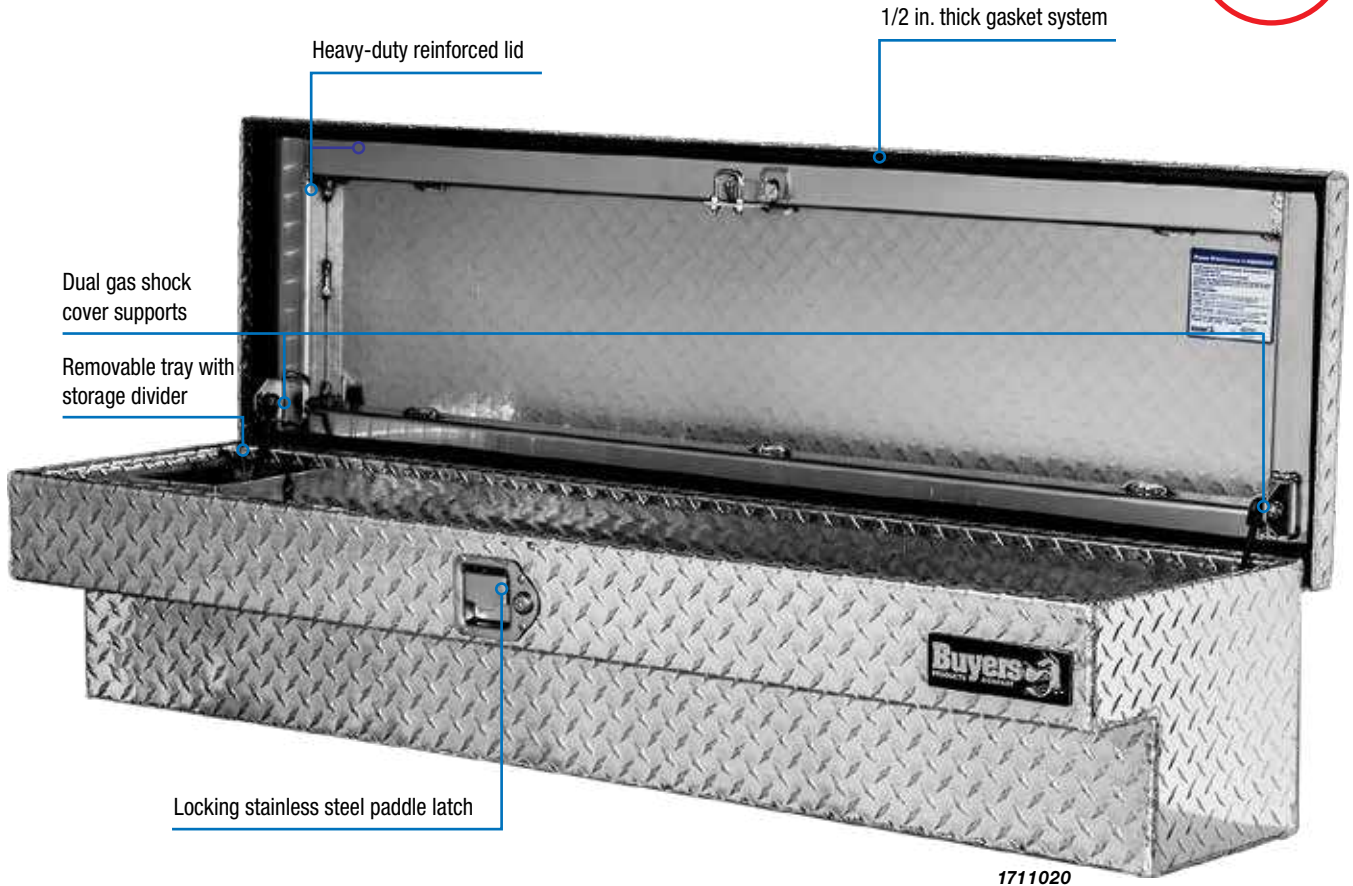

1711020

## Lo-Sider/Rail Features



Removable tray with storage divider



The cover support housing protects the gas shocks



Locking stainless steel paddle latch



Full weather stripping keeps dust and moisture out

## LO-SIDER WITH PADDLE LATCH

- .056" thick diamond tread
- Mounts along bed rail of pickups
- Locking stainless steel paddle latch
- Aluminum hinge is welded to the lid and bolted to the box
- Includes tray and dividers
- Mounting hardware included
- Fits full size pickups with 6-1/2' and 8' beds

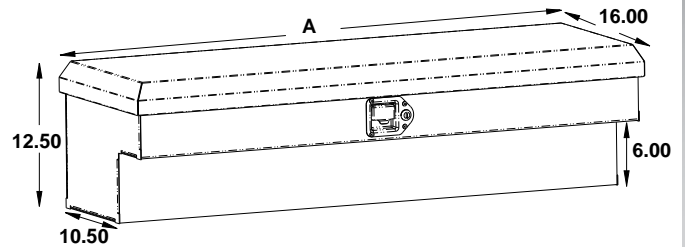

### Diamond Tread



| Part No. | Height | Depth | Width (A) | Cubic ft. | Wt. (lb) | Cat.       |
|----------|--------|-------|-----------|-----------|----------|------------|
| 1711010  | 12.5   | 10.5  | 16        | 47        | 3.4      | 23 530 (Y) |
| 1711020  | 12.5   | 10.5  | 16        | 56        | 4.0      | 47 530 (Y) |
| 1711025  | 12.5   | 10.5  | 16        | 70        | 5.2      | 52 530 (Y) |
| 1711030  | 12.5   | 10.5  | 16        | 87        | 6.3      | 63 530 (Y) |

### Black Diamond Tread



| Part No. | Height | Depth | Width (A) | Cubic ft. | Wt. (lb) | Cat.       |
|----------|--------|-------|-----------|-----------|----------|------------|
| 1721010  | 12.5   | 10.5  | 16        | 47        | 3.4      | 23 530 (Y) |
| 1721020  | 12.5   | 10.5  | 16        | 56        | 4.0      | 47 530 (Y) |
| 1721025  | 12.5   | 10.5  | 16        | 70        | 5.2      | 52 530 (Y) |
| 1721030  | 12.5   | 10.5  | 16        | 87        | 6.3      | 63 530 (Y) |

### Textured Matte Black Diamond Tread



| Part No. | Height | Depth | Width (A) | Cubic ft. | Wt. (lb) | Cat.       |
|----------|--------|-------|-----------|-----------|----------|------------|
| 1731020  | 12.5   | 10.5  | 16        | 56        | 4.0      | 47 530 (Y) |

# Storage Chests

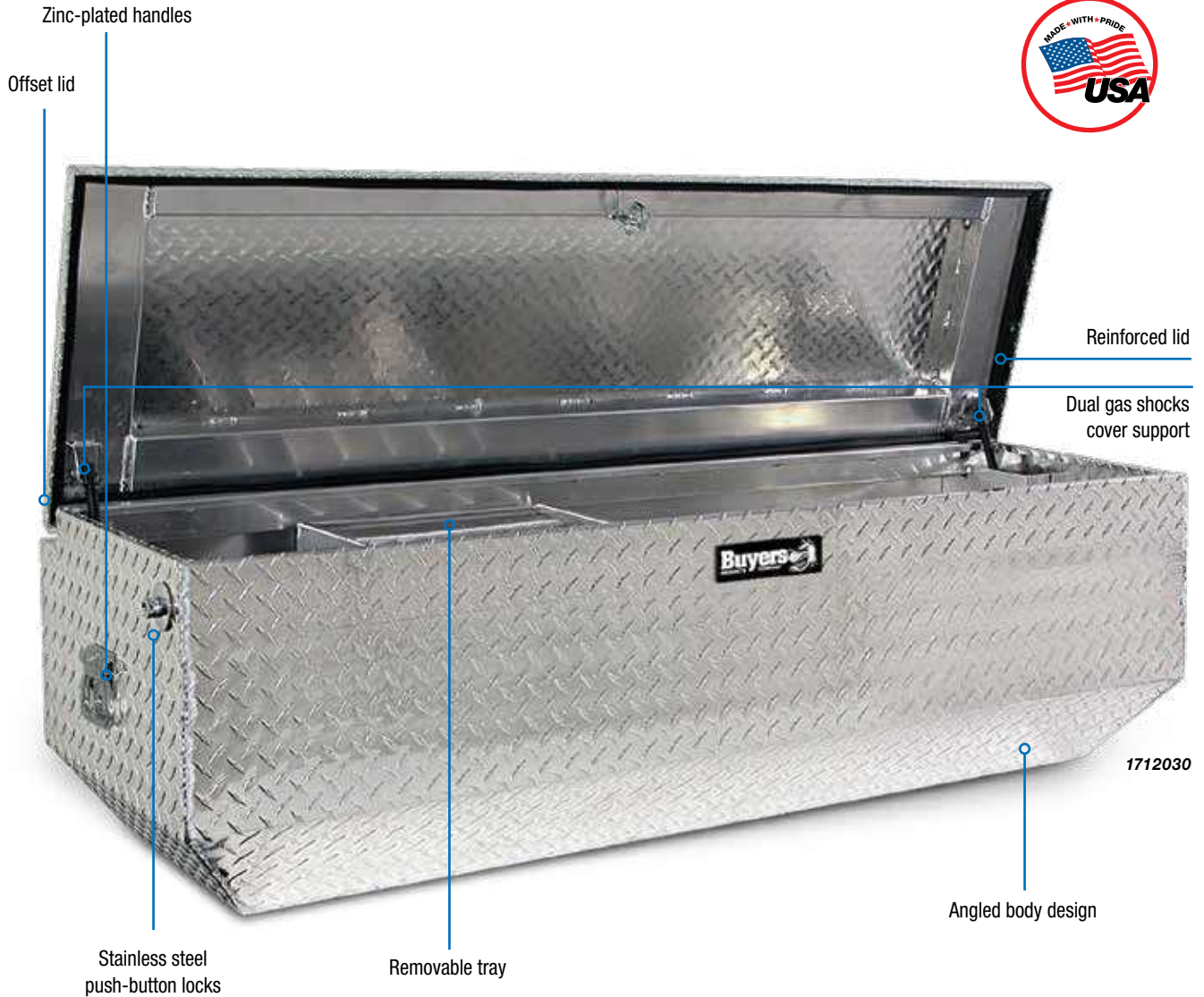

## Storage Chest Features



Gas shock cover support protects shocks from damage.



Two zinc-plated handles for easy lifting.



Reinforced lid for extra durability.



Angled body design is ideal for use with fifth wheel and goose-neck trailer applications.



## ANGLED BASE WITH PUSH-BUTTON LOCK

- .056" thick diamond tread
- Stainless steel one-touch push-button locks
- Continuous aluminum hinge is welded to the lid and bolted to the box
- Offset lid allows for 90° opening when placed against truck bed
- Door assisting gas shocks
- Angled body for use with fifth wheel or gooseneck trailer application
- Includes tray and dividers



### Diamond Tread Aluminum



| Part No.  | Height | Depth | Width (A/B) | Cubic ft. | Wt. (lb) | Cat.    |
|-----------|--------|-------|-------------|-----------|----------|---------|
| 1712010†  | 18.5   | 20/15 | 47/47       | 10        | 53       | 530 (Y) |
| 1712020†  | 18.5   | 20/15 | 55/54       | 12        | 55       | 530 (Y) |
| 1712030†† | 19     | 20/16 | 60/52       | 12.5      | 60       | 530 (Y) |
| 1712035†† | 19     | 27/27 | 60/52       | 18        | 74       | 530 (Y) |

†Boxes have angled base on front only

††Boxes have angled base on front and sides

### Textured Matte Black



| Part No. | Height | Depth | Width (A/B) | Cubic ft. | Wt. (lb) | Cat.    |
|----------|--------|-------|-------------|-----------|----------|---------|
| 1722010† | 18.5   | 20/15 | 47/47       | 10        | 53       | 530 (Y) |

†Boxes have angled base on front only

## JUMBO CHEST WITH PADDLE LATCH

- .100" thick diamond tread
- Locking stainless steel paddle latch
- Continuous aluminum hinge is welded to the lid and bolted to the box
- Zinc plated handles



### Diamond Tread Aluminum



| Part No. | Height | Depth | Width | Cubic ft. | Wt. (lb) | Cat.    |
|----------|--------|-------|-------|-----------|----------|---------|
| 1712110  | 24     | 24/22 | 49    | 15        | 74       | 530 (Y) |
| 1712120  | 30     | 30/28 | 49    | 24        | 92       | 530 (Y) |

# Storage Chests

## POLY CHEST WITH 2" RECEIVER MOUNT

- Durable, lightweight high density polyethylene construction
- Fully enclosed, water resistant design
- Mounts in 2" hitch receivers to provide portable, accessible storage
- Great for camping, fishing, tailgating, and more
- 17 cubic feet of functional space
- Holds up to 300 pounds
- Double walled lid with two lockable hasps (padlocks sold separately)
- Steel frame with black powder-coated finish
- Comes pre-drilled for easy assembly and installation
- Comes with all hardware including 5/8in. hitch pin



1707020

| Part No. | # Hasps | Height | Depth | Width    | Cubic ft. | Wt. (lb) | Cat.    |
|----------|---------|--------|-------|----------|-----------|----------|---------|
| 1707020  | 2       | 26     | 23/21 | 51/47.25 | 17        | 76       | 530 (Y) |



1707020

## POLY CHEST WITH HASP

- Lightweight, dent-resistant, high-density polyethylene body
- Box contents stay safe and secure behind a molded, double-wall, stainless steel hinged lid
- Corrosion and weather resistant stainless steel hasp and hinge made for use with combination lock or padlock (lock sold separately)
- Mount to floor of pickup beds, trailers or for use in garages



### Black, Single Hasp



1712230

| Part No.       | # Hasps | Height | Depth      | Width   | Cubic ft. | Wt. (lb) | Cat.    |
|----------------|---------|--------|------------|---------|-----------|----------|---------|
| <b>1712230</b> | 1       | 13.5   | 15/9.25    | 32/29.5 | 2.6       | 16       | 530 (Y) |
| <b>1712250</b> | 1       | 22.5   | 19.5/18.75 | 51/47   | 8.4       | 34       | 530 (Y) |

### Black, Dual Hasp



1712240

| Part No.       | # Hasps | Height | Depth    | Width    | Cubic ft. | Wt. (lb) | Cat.    |
|----------------|---------|--------|----------|----------|-----------|----------|---------|
| <b>1712240</b> | 2       | 17.25  | 19/13.25 | 44/41.25 | 6.3       | 28       | 530 (Y) |
| <b>1712255</b> | 2       | 26     | 23/21    | 51/47.25 | 17        | 46       | 530 (Y) |
| <b>1712260</b> | 2       | 23     | 25/19    | 77/73    | 18.8      | 52       | 530 (Y) |

# Wheel Well

## WHEEL WELL WITH PUSH-BUTTON LOCK

- .100" thick aluminum diamond tread aluminum
- Lid features gas shock and one-touch stainless steel push-button rotary locking mechanism
- Low profile over-the-wheel mounting offers convenient storage while maximizing pickup truck bed space
- Fits most pickups
- May also be mounted in front of wheel wells on full-size long bed pickups



### Diamond Tread

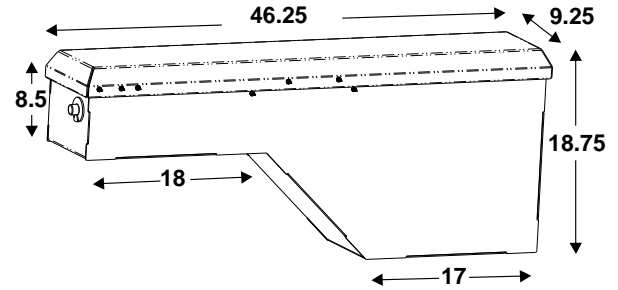

| Part No. | Description                               | Height        | Depth | Width           | Wt. (lb) | Cat.       |
|----------|---|---------------|-------|-----------------|----------|------------|
| 1711205  | Driver Side Rear/<br>Passenger Side Front | 18.75/<br>8.5 | 9.25  | 46.25/<br>18/17 | 26       | 530<br>(Y) |
| 1711206  | Passenger Side Rear/<br>Driver Side Front | 18.75/<br>8.5 | 9.25  | 46.25/<br>18/17 | 26       | 530<br>(Y) |

Fully concealed aluminum continuous hinge

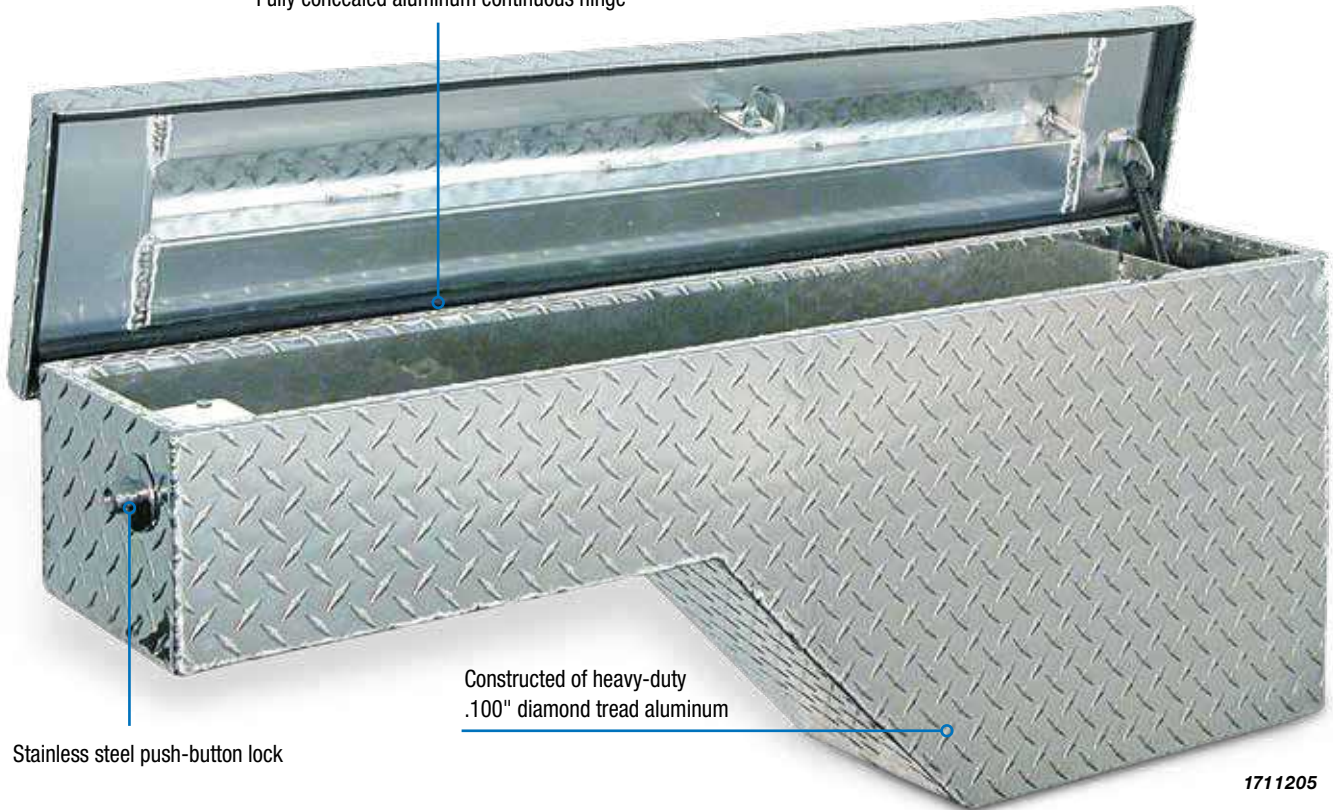

Constructed of heavy-duty  
.100" diamond tread aluminum

Stainless steel push-button lock

1711205

## HEAVY DUTY POLY STORAGE BINS

- Constructed from durable and rust-proof polyethylene for years of use
- Double panel sloped lid provides a weather-resistant barrier to keep contents dry
- Molded hand holds and fork lift slots allow for easy lifting and carrying
- Ideal for storing dry, loose materials like rock salt, grain, sand, seed or litter
- Suitable for indoor or outdoor use

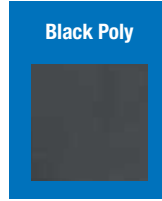

### Black, 20" High



| Part No. | Height | Depth | Width | Wt. (lb) | Cat.      |
|----------|--------|-------|-------|----------|-----------|
| 9031105  | 20     | 24    | 36    | 21       | 903-1 (N) |

**SHIPS UPS!**

### Black, 30" High



| Part No. | Height | Depth | Width | Wt. (lb) | Cat.      |
|----------|--------|-------|-------|----------|-----------|
| 9031100  | 30     | 24    | 36    | 28       | 903-1 (N) |

### Material Scoop



| Part No. | Height         | Depth | Width | Wt. (lb) | Cat.      |
|----------|----------------|-------|-------|----------|-----------|
| 9031110  | Material Scoop |       |       | 2.47     | 903-1 (N) |

# Trailer Tongues

## STEEL TRAILER TONGUE WITH PADDLE LATCH

- 15 gauge steel box and door
- Locking stainless steel paddle latch
- Stainless steel continuous hidden hinge
- Designed to mount to the front of A-frame style trailers

### Black

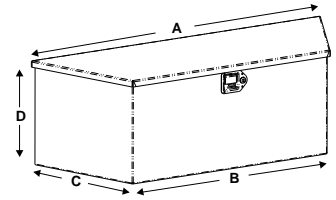
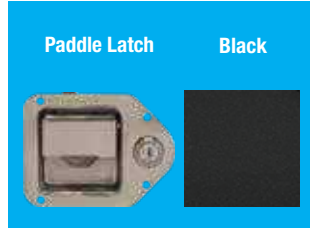

| Part No. | Height (D) | Depth (C) | Width (A/B) | Wt. (lb) | Cat.    |
|----------|------------|-----------|-------------|----------|---------|
| 1701280  | 15         | 14.5      | 34/22.5     | 51       | 530 (Y) |
| 1701281  | 12         | 13.25     | 26/14       | 33       | 530 (Y) |
| 1701285  | 18.5       | 15        | 49/37       | 74       | 530 (Y) |

## ALUMINUM TRAILER TONGUE WITH PADDLE LATCH

- .056 thick diamond tread aluminum
- Locking stainless steel paddle latch
- Aluminum continuous hidden hinge
- Designed to mount to the front of A-frame style trailers

### Diamond Tread

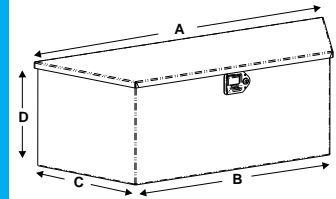

| Part No. | Height (D) | Depth (C) | Width (A/B) | Wt. (lb) | Cat.    |
|----------|------------|-----------|-------------|----------|---------|
| 1701380  | 15         | 14.5      | 34/20.7     | 17.5     | 530 (Y) |
| 1701385  | 18.5       | 15        | 49/37       | 28       | 530 (Y) |

## POLY TRAILER TONGUE WITH HASP

- Constructed of high-density polyethylene
- Designed to mount to the front of A-frame style trailers
- Corrosion and weather resistant stainless steel hasp and hinge made for use with combination lock or padlock (lock sold separately)

### Black

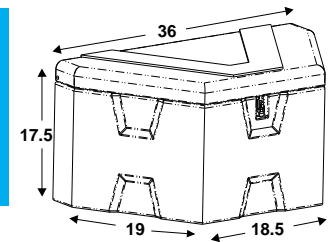

| Part No. | Height | Depth | Width | Cubic ft. | Wt. (lb) | Cat.    |
|----------|--------|-------|-------|-----------|----------|---------|
| 1701680  | 18     | 19    | 36/18 | 5.34      | 21       | 530 (Y) |

### White



| Part No. | Height | Depth | Width | Cubic ft. | Wt. (lb) | Cat.    |
|----------|--------|-------|-------|-----------|----------|---------|
| 1701679  | 18     | 19    | 36/18 | 5.34      | 21       | 530 (Y) |



# Class 8 Boxes



## WideOpen™ Box Features



Locking, polished stainless steel T-handle latch



Non-slip (grip strut) steps and stainless steel continuous hidden hinge



## WIDOPEN™ STEP BOXES

- Provides frame steps with built-in storage space
- Universal design fits Peterbilt®, Kenworth®, International®, Freightliner®, Western-Star®, Volvo®, and Mack® trucks
- Non-slip (grip strut) steps
- .125" smooth aluminum construction
- D-bulb door seal protects from the elements
- Locking, polished stainless steel T-handle latch
- Stainless steel continuous hidden hinge
- Corner gussets on door opening provide extra strength
- 1/8" thick integral corner braces provide mounting support
- For heavy loads and toolboxes wider than 18", #1701015 steel mounting brackets are recommended to prevent stress cracks



| Part No. | Height | Depth | Width | Wt. (lb) | Cat.    |
|----------|--------|-------|-------|----------|---------|
| 1705280  | 24     | 28    | 12    | 40       | 530 (Y) |
| 1705281  | 24     | 28    | 18    | 47       | 530 (Y) |
| 1705282  | 24     | 28    | 24    | 56       | 530 (Y) |
| 1705283  | 24     | 28    | 30    | 64       | 530 (Y) |
| 1705284  | 24     | 28    | 36    | 76       | 530 (Y) |
| 1705285  | 24     | 28    | 16    | 45       | 530 (Y) |
| 1705286  | 24     | 28    | 22    | 51       | 530 (Y) |



# Class 8 Boxes

## STEP BOXES

- Provides frame steps with built-in storage space
- Universal design fits Peterbilt®, Kenworth®, International®, Freightliner®, Western-Star®, Volvo®, and Mack® trucks
- Non-slip (grip punch) steps
- .125" smooth aluminum body
- .100" diamond tread aluminum door
- D-bulb door seal protects from the elements
- Locking die-cast T-handle compression latch
- Stainless steel continuous hidden hinge
- Corner gussets on door opening provide extra strength
- 1/8" thick integral corner braces provide mounting support (for heavy loads and toolboxes wider than 18", #1701015 steel mounting brackets are recommended to prevent stress cracks)



1705181



1705181 open

| Part No. | Height | Depth | Width | Wt. (lb) | Cat.    |
|----------|--------|-------|-------|----------|---------|
| 1705180  | 24     | 28    | 12    | 40       | 530 (Y) |
| 1705181  | 24     | 28    | 18    | 46       | 530 (Y) |
| 1705182  | 24     | 28    | 24    | 56       | 530 (Y) |
| 1705183  | 24     | 28    | 30    | 66       | 530 (Y) |

## FRAME STEPS

- Grip strut provides superior traction even in inclement weather
- Universal design fits Peterbilt®, Kenworth®, International®, Freightliner®, Western-Star®, Volvo®, and Mack® trucks
- Corrosion resistant aluminum construction with .188 in. thick sides for years of dependable service
- Universal 4-bolt mounting pattern is easy to install on most semi truck frames



5239018

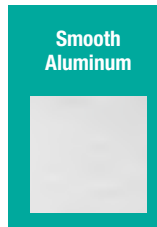

| Part No. | Height | Depth | Width | Wt. (lb) | Cat.    |
|----------|--------|-------|-------|----------|---------|
| 5239012  | 24     | 28    | 12    | 12       | 523 (Y) |
| 5239018  | 24     | 28    | 18    | 13       | 523 (Y) |
| 5239024  | 24     | 28    | 24    | 14       | 523 (Y) |

## IN-FRAME BOXES

- Mounts between truck frame rails
- Universal design fits Peterbilt®, Kenworth®, International®, Freightliner®, Western-Star®, Volvo®, and Mack® trucks
- Body constructed of .100" smooth aluminum
- .125" Diamond tread aluminum lid
- Built-in rain gutter with automotive bulb seal
- Adjustable stainless steel latch for use with combination lock or padlock (sold separately)
- Full width stainless steel hinge
- Includes Mounting Kit
- Universal Mounting Kit (1705399) is also available separately for purchase

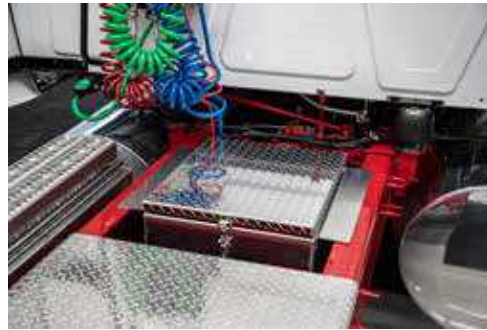

| Part No. | Height | Depth | Width | Wt. (lb) | Cat.    |
|----------|--------|-------|-------|----------|---------|
| 1705384  | 9      | 22    | 30    | 42       | 530 (Y) |
| 1705381† | 12     | 24    | 32    | 52       | 530 (Y) |

†Includes notched center channel to accommodate driveline or accessories

## CHAIN HOLDER

- Constructed of structural steel with aluminum diamond tread cover
- TIG welded
- Pre-drilled mounting holes
- Hinged diamond plate cover comes with lock hasp for secure use
- Keeps tire chains securely in place

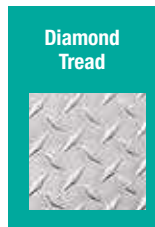

| Part No. | Height | Depth | Width | Wt. (lb) | Cat.    |
|----------|--------|-------|-------|----------|---------|
| 5910024  | 9      | 7.5   | 24    | 34       | 591 (N) |

# Parts & Accessories

## Die Cast Compression Latch



- Strong, secure compression operation
- Latch is secure and stays shut with the adjustable cam action roller engagement
- Helps keep dirt, grime, and dust out of your box
- Corrosion-resistant powder-coated housing
- Corrosion-resistant chrome plated T-handle
- Adjustable cam, from .850 in. to 1.320 in. (No tools required for adjustment)

**\*Replacement for Buyers boxes using L8816 and L3890RLS latch**

| Part No. | Description   | Wt. (lbs.) | Cat.    |
|----------|---|------------|---------|
| LL9000   | Single Point, Compression Latch with Blind Studs, 1/2" Gasket and Cylinder with keys included | 2.04       | 510 (N) |
| LL90003  | 3-Point, Compression Latch with Blind Studs, 1/2" Gasket and Cylinder with keys included      | 2.04       | 510 (N) |

## Heavy-Duty Standard Size Flush Mount Folding T-handle Latches



- Polished Stainless steel
- Available in single, double or triple point contact to address most applications
- Adjustable cam from 1.25" to 2" to accommodate door thicknesses
- Designed to mount into a 3.75" x 4" recess opening.  
(L8816 fits into 4.375" x 3.5" recess opening)



| Part No. | Description                                    | Wt. (lbs.) | Cat.    |
|----------|--|------------|---------|
| L882502  | 34" Replacement Rods for 2 and 3 point latches | 105        | 510 (N) |

| Part No. | Description  | Wt. (lbs.) | Cat.    |
|----------|--|------------|---------|
| L8815    | Stainless Steel T-Handle Latch with Mounting Holes, Cylinder & Keys Included             | 1.25       | 510 (N) |
| L8816    | Tall Flush Mount T-Handle Latch with Blind Studs, Cylinder & Keys Included               | 1.50       | 510 (N) |
| L8915    | Zinc Plated Stainless Steel T-Handle Latch with Mounting Holes, Cylinder & Keys Included | 1.25       | 510 (N) |
| L8825    | Standard Size 2 Point T-Handle Latch with Mounting Holes, Cylinder & Keys Included       | 2.50       | 510 (N) |
| L8835    | Standard Size 3 Point T-Handle Latch with Mounting Holes, Cylinder & Keys Included       | 2.75       | 510 (N) |
| L8855    | Standard Size Flush Mount T-Handle Latch with Blind Studs, Cylinder & Keys Included      | 1.26       | 510 (N) |
| L8815G0  | Replacement Gasket For L8815, L8855, and L8915   | 0.01       | 510 (N) |

## Poly Underbody Replacement Latch



- Polished Stainless steel
  - 3-Point latch
  - Adjustable cam from 0.25" to 1.6"
  - Designed to mount into a 4-3/8" x 3-1/2" recess opening
- \*Replacement for Buyers poly underbody boxes only, not compatible with standard underbody toolboxes**



| Part No. | Description                                    | Wt. (lbs.) | Cat.    |
|----------|--|------------|---------|
| L8816R   | 3-Point Latch Folding-T Handle, with Roller    | 1.43       | 510 (N) |
| L882502  | 34" Replacement Rods for 2 and 3 point latches | 105        | 510 (N) |

## Mini Size Tear Drop Latch



- Ideal for use on toolboxes and other small compartment doors
- Polished stainless steel finish
- Locking version includes cylinder and two keys

| Part No.       | Description   | Face Dims. (HxW) | Wt. (lbs.) | Cat.    |
|----------------|---|------------------|------------|---------|
| <b>8000SSL</b> | Stainless Steel Mini Size Tear Drop Style Latch (Locking)     | 4.38" x 3.25"    | 0.57       | 510 (N) |
| <b>8000SSN</b> | Stainless Steel Mini Size Tear Drop Style Latch (Non-Locking) | 4.38" x 3.25"    | 0.55       | 510 (N) |

## Standard Size Single-Point Rotary Paddle Latch



- Polished stainless steel
- Hidden studs
- Includes gasket, cylinder and keys
- Includes hasp for alternative lock. Requires 7/16" diameter pad lock shank (not included)

| Part No.        | Description  | Face Dims. (HxW) | Wt. (lbs.) | Cat.      |
|-----------------|--|------------------|------------|-----------|
| <b>L3890RLS</b> | Stainless Steel Rotary Single Point Paddle Latch, 1/4" Striker | 5.5" x 4.75"     | 1.40       | 510 (N)   |
| <b>3005833</b>  | Striker Plate/Bracket; for use with L3890RLS                   | -                | 0.26       | 530-1 (N) |

## Stainless Steel Adjustable Draw Latch



- Polished stainless steel
- Adjustable latch for use with combination lock or padlock (sold separately)
- Adjust the latching distance to compensate for gasket and panel misalignment
- Heavy-duty lever-action latch provides door-closing leverage for heavier gasketed door applications like toolboxes and other small compartment doors

| Part No.       | Description                           | Wt. (lb) | Cat.  |
|----------------|---------------------------------------|----------|-------|
| <b>3049352</b> | Stainless Steel Adjustable Draw Latch | .52      | 530-1 |

## Cylinder and Key

- For standard and mini size latches
- Various keys available



| Part No.           | Description  | Wt. (lbs.) | Cat.    |
|--------------------|--|------------|---------|
| <b>19CH545</b>     | Cylinder and Key   | 0.09       | 510 (N) |
| <b>88CH510</b>     | Cylinder Lock with 2 Keys  | 0.13       | 510 (N) |
| <b>39LL71</b>      | Cylinder and Key   | 0.09       | 510 (N) |
| <b>L38RLSCH545</b> | Cylinder for L3885RLS Latch  | 0.25       | 510 (N) |
| <b>88CH545</b>     | Cylinder for L8815/L8915/L8816 Latch   | 0.25       | 510 (N) |
| <b>CDC01Z</b>      | Zinc Die Cast Cylinder Dust Cover (Works with all Cylinders and Keys Listed Above) | 0.05       | 510 (N) |

## Push Button Lock and Key

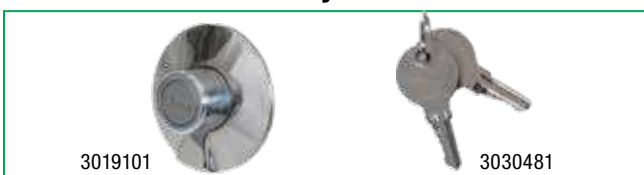

| Part No.       | Description                     | Wt. (lbs.) | Cat.      |
|----------------|---------------------------------|------------|-----------|
| <b>3019101</b> | Push Button Lock with Key       | 0.68       | 530-1 (N) |
| <b>3030481</b> | Spare Keys for Push Button Lock | 0.03       | 530-1 (N) |

## Parts & Accessories

### Replacement Tray for 2020+ Crossover Truck Tool Boxes

- Oversized powder-coated steel tray with dividers
- 3 Dividers are removable for flexible storage
- For use with the newly redesigned crossover and gull wing tool boxes (page 74-77)



| Part No. | Depth (in) | Width (in) | Wt. (lb) | Cat.    |
|----------|------------|------------|----------|---------|
| 3043331  | 15.375     | 18         | 7.64     | 530 (Y) |
| 3047140  | 15.375     | 25         | 10.56    | 530 (Y) |

### Gas Shocks

- Dampened extension
- Undampened compression
- Black powder-coated cylinder



| Part No.     | Extended Length   | Compressed Length | Stroke | Rod Diameter | Cylinder Diameter | Ball Socket Diameter | Force Rating (lbs.) | Wt. (lbs.) | Cat.      |
|--------------|---|-------------------|--------|--------------|-------------------|----------------------|---------------------|------------|-----------|
| 3010339      | 17"   | 10"               | 7"     | 6mm          | 15mm              | 10mm                 | 20                  | 0.42       | 530-1 (N) |
| 3028786      | 13.93"  | 8.5"              | 5.5"   | 8mm          | 18mm              | 10mm                 | 40                  | 0.51       | 520 (N)   |
| 3045508      | 12"   | 8"                | 4"     | 6mm          | 15mm              | 10mm                 | 40                  | 0.27       | 530-1 (N) |
| 3026586      | 12"   | 8"                | 4"     | 6mm          | 15mm              | 10mm                 | 50                  | 0.42       | 530-1 (N) |
| 3029916      | 12"   | 8"                | 4"     | 6mm          | 15mm              | 10mm                 | 60                  | 0.27       | 530-1 (N) |
| 3028392      | 12"   | 8"                | 4"     | 6mm          | 15mm              | 10mm                 | 80                  | 0.42       | 530-1 (N) |
| 3029917      | 12"   | 8"                | 4"     | 9.65mm       | 18.13mm           | 10mm                 | 100                 | 0.38       | 530-1 (N) |
| 3022729      | 12"   | 8"                | 4"     | 6mm          | 15mm              | 10mm                 | 25                  | 0.27       | 530-1 (N) |
| 3023460      | 19.63"  | 11.63"            | 8"     | 9.98mm       | 21.59mm           | 10mm                 | 250                 | 0.85       | 903-2 (N) |
| 3008745      | 10mm Ball Stud (Sold Separately except for 3028786)           |                   |        |              |                   |                      |                     | 0.03       | 530-1 (N) |
| FNE031018034 | Nylock Nut for Ball Stud (Sold Separately except for 3023460) |                   |        |              |                   |                      |                     | 0.01       | 530-1 (N) |

### Dry-Mat Tile

- 3/4" thick, tough automotive grade recycled plastic
- Provides fast evaporation while protecting the surface below
- Maintains original shape and color
- Fast, easy installation

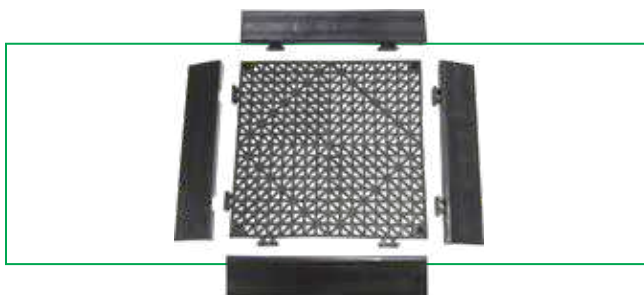

| Part No. | Description | Dim       | Wt. (lbs.) | Cat.    |
|----------|-------------|-----------|------------|---------|
| DM1212B  | Tile        | 12" x 12" | 1.42       | 880 (N) |
| DM0212BF | Female Edge | 2" x 12"  | 0.33       | 880 (N) |
| DM0212BM | Male Edge   | 2" x 12"  | 0.35       | 880 (N) |

## Trailer Tongue Display Stand



- Works with all Buyers Products Trailer Tongue Tool Boxes
- Contact your Buyers Products sales representative for additional details
- Not intended for use as a retail selling shelf fixture



| Part No.       | Description                  | Cat. |
|----------------|------------------------------|------|
| <b>3047012</b> | Trailer Tongue Display Stand | 994  |

## Underbody Truck Tool Box Display Stand



- Works with all Buyers Products 18x18x36 Underbody Truck boxes
- Contact your Buyers Products sales representative for additional details
- Not intended for use as a retail selling shelf fixture



| Part No.     | Description                            | Cat. |
|--------------|--|------|
| <b>99170</b> | Underbody Truck Tool Box Display Stand | 994  |

## Crossover and Gull Wing Display Stand



- Works with Buyers Products Crossover and Gull Wings truck tool boxes that are 18x20x71
- Contact your Buyers Products sales representative for additional details
- Not intended for use as a retail selling shelf fixture



| Part No.        | Description                           | Cat. |
|-----------------|---------------------------------------|------|
| <b>3052089*</b> | Crossover and Gull Wing Display Stand | 994  |

\* **NEW** PRODUCTS





## Barn Door Replacement Parts

| PART NO. | DOORS WITH LATCH | DOOR WITHOUT LATCH | LATCHES |
|----------|------------------|--------------------|---------|
| 1702225  | 1702225DOORBWLCH | 1702225DOORBWLCH   | LL9000  |
| 1702230  | 1702230DOORBWLCH | 1702230DOORBWLCH   | LL9000  |
| 1702235  | 1702235DOORBWLCH | 1702235DOORBWLCH   | LL90003 |
| 1702240  | 1702240DOORBWLCH | 1702240DOORBWLCH   | LL90003 |
| 1702250  | 1702250DOORBWLCH | 1702250DOORBWLCH   | LL90003 |
| 1705200  | 1705200DOORBWLCH | 1705200DOORBWLCH   | LL90003 |
| 1705201  | 1705201DOORBWLCH | 1705201DOORBWLCH   | LL90003 |
| 1705203  | 1705203DOORBWLCH | 1705203DOORBWLCH   | LL90003 |
| 1705205  | 1705205DOORBWLCH | 1705205DOORBWLCH   | LL90003 |
| 1705210  | 1705210DOORBWLCH | 1705210DOORBWLCH   | LL90003 |
| 1705215  | 1705215DOORBWLCH | 1705215DOORBWLCH   | LL90003 |
| 1705295  | 1705295DOORBWLCH | 1705295DOORBWLCH   | LL9000  |
| 1705300  | 1705300DOORBWLCH | 1705300DOORBWLCH   | LL9000  |
| 1705303  | 1705303DOORBWLCH | 1705303DOORBWLCH   | LL90003 |
| 1705305  | 1705305DOORBWLCH | 1705305DOORBWLCH   | LL90003 |
| 1705310  | 1705310DOORBWLCH | 1705310DOORBWLCH   | LL90003 |
| 1705315  | 1705315DOORBWLCH | 1705315DOORBWLCH   | LL90003 |
| 1705333  | 1705333DOORBWLCH | 1705333DOORBWLCH   | LL90003 |
| 1705335  | 1705335DOORBWLCH | 1705335DOORBWLCH   | LL90003 |
| 1705395  | 1705395DOORBWLCH | 1705395DOORBWLCH   | LL9000  |
| 1705340  | 1705340DOORBWLCH | 1705340DOORBWLCH   | LL90003 |
| 1705345  | 1705345DOORBWLCH | 1705345DOORBWLCH   | LL90003 |
| 1705350  | 1705350DOORBWLCH | 1705350DOORBWLCH   | LL90003 |
| 1705401  | 1705401DOORBWLCH | 1705401DOORBWLCH   | LL9000  |
| 1705403  | 1705403DOORBWLCH | 1705403DOORBWLCH   | LL9003  |
| 1705405  | 1705405DOORBWLCH | 1705405DOORBWLCH   | LL90003 |
| 1705410  | 1705410DOORBWLCH | 1705410DOORBWLCH   | LL90003 |

| PART NO. | DOORS WITH LATCH | DOOR WITHOUT LATCH | LATCHES |
|----------|------------------|--------------------|---------|
| 1705415  | 1705415DOORBWLCH | 1705415DOORBWLCH   | LL90003 |
| 1705420  | 1705420DOORBWLCH | 1705420DOORBWLCH   | LL90003 |
| 1705425  | 1705425DOORBWLCH | 1705425DOORBWLCH   | LL90003 |
| 1705430  | 1705430DOORBWLCH | 1705430DOORBWLCH   | LL90003 |
| 1705431  | 1705431DOORBWLCH | 1705431DOORBWLCH   | LL9000  |
| 1705433  | 1705433DOORBWLCH | 1705433DOORBWLCH   | LL9003  |
| 1705435  | 1705435DOORBWLCH | 1705435DOORBWLCH   | LL90003 |
| 1705440  | 1705440DOORBWLCH | 1705440DOORBWLCH   | LL90003 |
| 1705445  | 1705445DOORBWLCH | 1705445DOORBWLCH   | LL90003 |
| 1705450  | 1705450DOORBWLCH | 1705450DOORBWLCH   | LL90003 |
| 1705795  | 1705795DOORBWLCH | 1705795DOORBWLCH   | LL9000  |
| 1705800  | 1705800DOORBWLCH | 1705800DOORBWLCH   | LL9000  |
| 1705825  | 1705825DOORBWLCH | 1705825DOORBWLCH   | LL9000  |
| 1705895  | 1705895DOORBWLCH | 1705895DOORBWLCH   | LL9000  |
| 1705900  | 1705900DOORBWLCH | 1705900DOORBWLCH   | LL9000  |
| 1705903  | 1705903DOORBWLCH | 1705903DOORBWLCH   | LL9003  |
| 1705931  | 1705931DOORBWLCH | 1705931DOORBWLCH   | LL9000  |
| 1705933  | 1705933DOORBWLCH | 1705933DOORBWLCH   | LL9000  |
| 1706795  | 1706795DOORBWLCH | 1706795DOORBWLCH   | LL9000  |
| 1706800  | 1706800DOORBWLCH | 1706800DOORBWLCH   | LL9000  |
| 1706825  | 1706825DOORBWLCH | 1706825DOORBWLCH   | LL9000  |
| 1706895  | 1706895DOORBWLCH | 1706895DOORBWLCH   | LL9000  |
| 1706900  | 1706900DOORBWLCH | 1706900DOORBWLCH   | LL9000  |
| 1706903  | 1706903DOORBWLCH | 1706903DOORBWLCH   | LL9003  |
| 1706931  | 1706931DOORBWLCH | 1706931DOORBWLCH   | LL9000  |
| 1706933  | 1706933DOORBWLCH | 1706933DOORBWLCH   | LL9003  |

## CAM Lock Replacement Parts

### ALUMINUM DOOR

| PART NO. | ROD SIDE DOOR  | HASP SIDE DOOR  | CAMLOCK HARDWARE KIT |
|----------|----------------|-----------------|----------------------|
| 1762600  | 1762600DOORROD | 1762600DOORHASP | 3052380              |
| 1762603  | 1762603DOORROD | 1762603DOORHASP | 3052380              |
| 1762606  | 1762606DOORROD | 1762606DOORHASP | 3052380              |
| 1762609  | 1762609DOORROD | 1762609DOORHASP | 3052380              |
| 1762621  | 1762621DOORROD | 1762621DOORHASP | 3052380              |
| 1762624  | 1762624DOORROD | 1762624DOORHASP | 3052380              |
| 1762627  | 1762627DOORROD | 1762627DOORHASP | 3052380              |
| 1762630  | 1762630DOORROD | 1762630DOORHASP | 3052380              |
| 1762639  | 1762639DOORROD | 1762639DOORHASP | 3052380              |
| 1762642  | 1762642DOORROD | 1762642DOORHASP | 3052380              |
| 1762645  | 1762645DOORROD | 1762645DOORHASP | 3052380              |
| 1762648  | 1762648DOORROD | 1762648DOORHASP | 3052380              |

### STAINLESS STEEL DOOR

| PART NO. | ROD SIDE DOOR  | HASP SIDE DOOR  | CAMLOCK HARDWARE KIT |
|----------|----------------|-----------------|----------------------|
| 1763100  | 1763100DOORROD | 1763100DOORHASP | 3052380              |
| 1763103  | 1763103DOORROD | 1763103DOORHASP | 3052380              |
| 1763106  | 1763106DOORROD | 1763106DOORHASP | 3052380              |
| 1763109  | 1763109DOORROD | 1763109DOORHASP | 3052380              |
| 1763121  | 1763121DOORROD | 1763121DOORHASP | 3052380              |
| 1763124  | 1763124DOORROD | 1763124DOORHASP | 3052380              |
| 1763127  | 1763127DOORROD | 1763127DOORHASP | 3052380              |
| 1763130  | 1763130DOORROD | 1763130DOORHASP | 3052380              |
| 1763139  | 1763139DOORROD | 1763139DOORHASP | 3052380              |
| 1763142  | 1763142DOORROD | 1763142DOORHASP | 3052380              |
| 1763145  | 1763145DOORROD | 1763145DOORHASP | 3052380              |
| 1763148  | 1763148DOORROD | 1763148DOORHASP | 3052380              |

| PART NO.      | PAGE NO. | PART NO.         | PAGE NO. | PART NO.     | PAGE NO. | PART NO.     | PAGE NO. | PART NO.     | PAGE NO. |
|---------------|----------|------------------|----------|--------------|----------|--------------|----------|--------------|----------|
| 1701000.....  | 35       | 1702410.....     | 12       | 1703322..... | 11       | 1705201..... | 29       | 1705931..... | 24       |
| 1701001.....  | 35       | 1702411.....     | 13, 15   | 1703324..... | 11       | 1705203..... | 29       | 1705933..... | 24       |
| 1701005.....  | 34       | 1702415.....     | 12       | 1703326..... | 11       | 1705205..... | 29       | 1705935..... | 24       |
| 1701005B..... | 34       | 1702417.....     | 12       | 1703328..... | 11       | 1705210..... | 29       | 1705940..... | 24       |
| 1701006.....  | 34       | 1702500.....     | 19       | 1703330..... | 11       | 1705215..... | 29       | 1705945..... | 24       |
| 1701006B..... | 34       | 1702503.....     | 19       | 1703349..... | 11       | 1705280..... | 89       | 1705950..... | 24       |
| 1701010.....  | 34       | 1702505.....     | 19       | 1703350..... | 11       | 1705281..... | 89       | 1706400..... | 22       |
| 1701010B..... | 34       | 1702510.....     | 19       | 1703351..... | 13       | 1705282..... | 89       | 1706403..... | 22       |
| 1701011.....  | 34       | 1702595.....     | 17       | 1703352..... | 13       | 1705283..... | 89       | 1706405..... | 22       |
| 1701011B..... | 34       | 1702600.....     | 17       | 1703353..... | 11       | 1705284..... | 89       | 1706410..... | 22       |
| 1701012.....  | 34       | 1702603.....     | 17       | 1703355..... | 13       | 1705285..... | 89       | 1706415..... | 22       |
| 1701015.....  | 34       | 1702605.....     | 17       | 1703400..... | 12, 63   | 1705286..... | 89       | 1706420..... | 22       |
| 1701016.....  | 34       | 1702610.....     | 17       | 1703403..... | 12, 63   | 1705295..... | 28       | 1706425..... | 22       |
| 1701030.....  | 35       | 1702650.....     | 18       | 1703404..... | 13, 63   | 1705300..... | 28       | 1706430..... | 22       |
| 1701031.....  | 35       | 1702653.....     | 18       | 1703405..... | 12       | 1705303..... | 28       | 1706500..... | 23       |
| 1701040.....  | 35       | 1702655.....     | 18       | 1703495..... | 12       | 1705305..... | 28       | 1706503..... | 23       |
| 1701041.....  | 35       | 1702660.....     | 18       | 1703700..... | 16       | 1705310..... | 28       | 1706505..... | 23       |
| 1701280.....  | 86       | 1702700.....     | 16       | 1703703..... | 16       | 1705315..... | 28       | 1706510..... | 23       |
| 1701281.....  | 86       | 1702703.....     | 16       | 1703705..... | 16       | 1705325..... | 28       | 1706515..... | 23       |
| 1701285.....  | 86       | 1702705.....     | 16       | 1703900..... | 12, 63   | 1705333..... | 28       | 1706520..... | 23       |
| 1701351.....  | 40       | 1702710.....     | 16       | 1704300..... | 11       | 1705335..... | 28       | 1706525..... | 23       |
| 1701356.....  | 40       | 1702715.....     | 16       | 1704303..... | 11       | 1705340..... | 28       | 1706530..... | 23       |
| 1701361.....  | 40       | 1702725.....     | 16       | 1704305..... | 11       | 1705345..... | 28       | 1706795..... | 28       |
| 1701363.....  | 40       | 1702840.....     | 39       | 1704310..... | 11       | 1705350..... | 28       | 1706800..... | 28       |
| 1701364.....  | 40       | 1702840TRAY..... | 39       | 1704315..... | 11       | 1705381..... | 91       | 1706803..... | 28       |
| 1701365.....  | 40       | 1702850.....     | 39       | 1704400..... | 12       | 1705384..... | 91       | 1706805..... | 28       |
| 1701380.....  | 86       | 1702850TRAY..... | 39       | 1704403..... | 12       | 1705395..... | 24       | 1706810..... | 28       |
| 1701385.....  | 86       | 1702860.....     | 39       | 1704405..... | 12       | 1705401..... | 24       | 1706815..... | 28       |
| 1701551.....  | 41       | 1702860TRAY..... | 39       | 1704410..... | 12       | 1705403..... | 24       | 1706825..... | 28       |
| 1701556.....  | 41       | 1702880.....     | 39       | 1704415..... | 12       | 1705405..... | 24       | 1706833..... | 28       |
| 1701561.....  | 41       | 1702880TRAY..... | 39       | 1704600..... | 17       | 1705410..... | 24       | 1706835..... | 28       |
| 1701563.....  | 41       | 1702890.....     | 39       | 1704603..... | 17       | 1705415..... | 24       | 1706840..... | 28       |
| 1701564.....  | 41       | 1702890TRAY..... | 39       | 1704605..... | 17       | 1705420..... | 24       | 1706845..... | 28       |
| 1701565.....  | 41       | 1702895.....     | 39       | 1704610..... | 17       | 1705425..... | 24       | 1706850..... | 28       |
| 1701568.....  | 41       | 1702895TRAY..... | 39       | 1704615..... | 17       | 1705430..... | 24       | 1706855..... | 28       |
| 1701679.....  | 86       | 1702900.....     | 12       | 1704700..... | 16       | 1705431..... | 24       | 1706895..... | 25       |
| 1701680.....  | 86       | 1702905.....     | 12       | 1704703..... | 16       | 1705433..... | 24       | 1706900..... | 25       |
| 1701768.....  | 40       | 1702910.....     | 12       | 1704705..... | 16       | 1705435..... | 24       | 1706903..... | 25       |
| 1702100.....  | 14       | 1702920.....     | 39       | 1704710..... | 16       | 1705435..... | 24       | 1706905..... | 25       |
| 1702103.....  | 14       | 1702920TRAY..... | 39       | 1704715..... | 16       | 1705440..... | 24       | 1706910..... | 25       |
| 1702105.....  | 14       | 1702940.....     | 39       | 1704715..... | 16       | 1705445..... | 24       | 1706915..... | 25       |
| 1702110.....  | 14       | 1702940TRAY..... | 39       | 1705100..... | 30       | 1705450..... | 24       | 1706920..... | 25       |
| 1702115.....  | 14       | 1702950.....     | 39       | 1705101..... | 30       | 1705450..... | 24       | 1706925..... | 25       |
| 1702200.....  | 14       | 1702950TRAY..... | 39       | 1705102..... | 30       | 1705640..... | 44       | 1706925..... | 25       |
| 1702203.....  | 14       | 1702960.....     | 39       | 1705103..... | 30       | 1705641..... | 45       | 1706930..... | 25       |
| 1702205.....  | 14       | 1702960TRAY..... | 39       | 1705105..... | 30       | 1705650..... | 44       | 1706931..... | 25       |
| 1702210.....  | 14       | 1702965.....     | 16       | 1705110..... | 30       | 1705651..... | 45       | 1706933..... | 25       |
| 1702215.....  | 14       | 1702980.....     | 39       | 1705115..... | 30       | 1705660..... | 44       | 1706935..... | 25       |
| 1702225.....  | 29       | 1702980TRAY..... | 39       | 1705118..... | 30       | 1705795..... | 28       | 1706940..... | 25       |
| 1702230.....  | 29       | 1702990.....     | 39       | 1705119..... | 30       | 1705800..... | 28       | 1706945..... | 25       |
| 1702235.....  | 29       | 1702990TRAY..... | 39       | 1705120..... | 30       | 1705803..... | 28       | 1706950..... | 25       |
| 1702240.....  | 29       | 1703000.....     | 39       | 1705125..... | 30       | 1705805..... | 28       | 1706960..... | 22       |
| 1702250.....  | 29       | 1703000TRAY..... | 39       | 1705130..... | 30       | 1705810..... | 28       | 1706963..... | 22       |
| 1702295.....  | 11       | 1703020.....     | 39       | 1705133..... | 30       | 1705815..... | 28       | 1706965..... | 22       |
| 1702300.....  | 11       | 1703020TRAY..... | 39       | 1705135..... | 30       | 1705825..... | 28       | 1706970..... | 22       |
| 1702303.....  | 11       | 1703100.....     | 14       | 1705140..... | 30       | 1705833..... | 28       | 1706975..... | 22       |
| 1702305.....  | 11       | 1703103.....     | 14       | 1705145..... | 30       | 1705835..... | 28       | 1706980..... | 22       |
| 1702306.....  | 13       | 1703150.....     | 14       | 1705147..... | 30       | 1705840..... | 28       | 1706985..... | 22       |
| 1702310.....  | 11       | 1703203.....     | 14       | 1705148..... | 30       | 1705845..... | 28       | 1706990..... | 22       |
| 1702311.....  | 13       | 1703205.....     | 14       | 1705149..... | 30       | 1705850..... | 28       | 1707020..... | 82       |
| 1702315.....  | 11       | 1703300.....     | 11, 63   | 1705150..... | 30       | 1705855..... | 24       | 1707020..... | 82       |
| 1702317.....  | 11       | 1703303.....     | 11, 63   | 1705153..... | 30       | 1705895..... | 24       | 1707960..... | 22       |
| 1702325.....  | 11       | 1703304.....     | 13, 63   | 1705160..... | 30       | 1705900..... | 24       | 1707963..... | 22       |
| 1702400.....  | 12       | 1703305.....     | 11       | 1705180..... | 90       | 1705903..... | 24       | 1707965..... | 22       |
| 1702403.....  | 12       | 1703310.....     | 11       | 1705181..... | 90       | 1705905..... | 24       | 1707970..... | 22       |
| 1702405.....  | 12       | 1703312.....     | 11       | 1705182..... | 90       | 1705910..... | 24       | 1707975..... | 22       |
| 1702406.....  | 13, 15   | 1703320.....     | 11       | 1705183..... | 90       | 1705915..... | 24       | 1707975..... | 22       |
|               |          |                  |          | 1705200..... | 29       | 1705920..... | 24       | 1707980..... | 22       |
|               |          |                  |          |              |          | 1705925..... | 24       | 1707985..... | 22       |
|               |          |                  |          |              |          | 1705930..... | 24       | 1707990..... | 22       |
|               |          |                  |          |              |          |              |          | 1708310..... | 11       |

| PART NO.     | PAGE NO. | PART NO.     | PAGE NO. | PART NO.     | PAGE NO. | PART NO.       | PAGE NO. | PART NO.          | PAGE NO. |
|--------------|----------|--------------|----------|--------------|----------|----------------|----------|-------------------|----------|
| 1708410..... | 12       | 1722410..... | 77       | 1735100..... | 32       | 19CH545.....   | 93       | BP824624.....     | 53       |
| 1708710..... | 16       | 1722413..... | 77       | 1735103..... | 32       | 3005833.....   | 93       | BP824624B.....    | 55       |
| 1709410..... | 75       | 1722420..... | 77       | 1735105..... | 32       | 3008086.....   | 64       | BP824624P.....    | 55       |
| 1709415..... | 75       | 1722423..... | 77       | 1735130..... | 32       | 3008745.....   | 94       | BP824624W.....    | 55       |
| 1709420..... | 75       | 1722551..... | 41       | 1735133..... | 32       | 3009122.....   | 65       | BP825524.....     | 49       |
| 1709425..... | 75       | 1722556..... | 41       | 1735135..... | 32       | 3009938.....   | 65       | BP826224.....     | 49       |
| 1709430..... | 75       | 1722561..... | 41       | 1739410..... | 75       | 3010339.....   | 94       | BP826254.....     | 61       |
| 1710410..... | 77       | 1722563..... | 41       | 1739415..... | 75       | 3019101.....   | 93       | BP826524.....     | 49       |
| 1710413..... | 77       | 1722564..... | 41       | 1739420..... | 75       | 3022729.....   | 94       | BP826524B.....    | 51       |
| 1710420..... | 77       | 1722565..... | 41       | 1739425..... | 75       | 3023460.....   | 94       | BP826524P.....    | 51       |
| 1710423..... | 77       | 1722568..... | 41       | 1739430..... | 75       | 3026586.....   | 94       | BP826524W.....    | 51       |
| 1711010..... | 79       | 1722768..... | 40       | 1751651..... | 42       | 3028392.....   | 94       | BP827024.....     | 49       |
| 1711020..... | 79       | 1725100..... | 31       | 1751656..... | 42       | 3028786.....   | 94       | BP827054.....     | 61       |
| 1711025..... | 79       | 1725101..... | 31       | 1751661..... | 42       | 3029916.....   | 94       | BP855524B.....    | 51       |
| 1711030..... | 79       | 1725102..... | 31       | 1751663..... | 42       | 3029917.....   | 94       | BP855524BSST..... | 51       |
| 1711205..... | 84       | 1725103..... | 31       | 1751664..... | 42       | 3030481.....   | 93       | BP855524P.....    | 51       |
| 1711206..... | 84       | 1725105..... | 31       | 1751665..... | 42       | 3035896.....   | 67       | BP855524W.....    | 51       |
| 1712010..... | 81       | 1725110..... | 31       | 1751668..... | 42       | 3037014.....   | 65       | BP855548B.....    | 61       |
| 1712020..... | 81       | 1725115..... | 31       | 1752151..... | 42       | 3037014A.....  | 65       | BP855548W.....    | 61       |
| 1712030..... | 81       | 1725116..... | 31       | 1752156..... | 42       | 3043331.....   | 94       | BP855924.....     | 53       |
| 1712035..... | 81       | 1725118..... | 31       | 1752161..... | 42       | 3045508.....   | 94       | BP855924B.....    | 55       |
| 1712110..... | 81       | 1725119..... | 31       | 1752163..... | 42       | 3047012.....   | 95       | BP855924BSST..... | 55       |
| 1712120..... | 81       | 1725120..... | 31       | 1752164..... | 42       | 3047140.....   | 94       | BP855924P.....    | 55       |
| 1712200..... | 32       | 1725125..... | 31       | 1752165..... | 42       | 3049352.....   | 93       | BP855924W.....    | 55       |
| 1712205..... | 32       | 1725130..... | 31       | 1752168..... | 42       | 3052089.....   | 95       | BP925824.....     | 49       |
| 1712210..... | 32       | 1725133..... | 31       | 1752800..... | 8        | 39LL71.....    | 93       | BP925824B.....    | 51       |
| 1712230..... | 83       | 1725135..... | 31       | 1752803..... | 8        | 5239012.....   | 90       | BP925824P.....    | 51       |
| 1712240..... | 83       | 1725140..... | 31       | 1752805..... | 8        | 5239018.....   | 90       | BP925824W.....    | 51       |
| 1712250..... | 83       | 1725145..... | 31       | 1752810..... | 8        | 5239024.....   | 90       | BP964824.....     | 59       |
| 1712255..... | 83       | 1725147..... | 31       | 1752815..... | 8, 38    | 5621002.....   | 67       | BP964824B.....    | 59       |
| 1712260..... | 83       | 1725148..... | 31       | 1752825..... | 8, 38    | 562109166..... | 67       | BP964824BLL.....  | 59       |
| 1715100..... | 31       | 1725149..... | 31       | 1752835..... | 8, 38    | 562133202..... | 67       | BP964824P.....    | 59       |
| 1715105..... | 31       | 1725150..... | 31       | 1752836..... | 8, 38    | 5621827.....   | 67       | BP964824W.....    | 59       |
| 1715110..... | 31       | 1725153..... | 31       | 1753151..... | 43       | 5621928.....   | 67       | BP964824WLL.....  | 59       |
| 1715115..... | 31       | 1725160..... | 31       | 1753156..... | 43       | 5622029.....   | 66       | BP965724.....     | 57       |
| 1717100..... | 33       | 1725640..... | 44       | 1753161..... | 43       | 5622120.....   | 66       | BP965724B.....    | 57       |
| 1717105..... | 33       | 1725641..... | 45       | 1753163..... | 43       | 5622436.....   | 67       | BP965724W.....    | 57       |
| 1717110..... | 33       | 1725650..... | 44       | 1753164..... | 43       | 5622537.....   | 67       | CDC01Z.....       | 93       |
| 1720410..... | 77       | 1725651..... | 45       | 1753165..... | 43       | 5622840.....   | 66       | DM0212BF.....     | 94       |
| 1720413..... | 77       | 1725660..... | 44       | 1753168..... | 43       | 5622941.....   | 66       | DM0212BM.....     | 94       |
| 1720420..... | 77       | 1729410..... | 75       | 1754800..... | 8        | 5623654.....   | 67       | DM1212B.....      | 94       |
| 1720423..... | 77       | 1729415..... | 75       | 1754803..... | 8        | 5623755.....   | 67       | FNE031018034..... | 94       |
| 1721010..... | 79       | 1729420..... | 75       | 1754805..... | 8        | 5623856.....   | 66       | L3890RLS.....     | 93       |
| 1721020..... | 79       | 1729425..... | 75       | 1762600..... | 27       | 5623957.....   | 66       | L38RLSCH545.....  | 93       |
| 1721025..... | 79       | 1729430..... | 75       | 1762603..... | 27       | 5624872.....   | 67       | L8815.....        | 92       |
| 1721030..... | 79       | 1731020..... | 79       | 1762606..... | 27       | 5624973.....   | 67       | L8815G0.....      | 92       |
| 1721351..... | 40       | 1732300..... | 15       | 1762609..... | 27       | 5625276.....   | 66       | L8816.....        | 92       |
| 1721356..... | 40       | 1732303..... | 15       | 1762621..... | 27       | 5625377.....   | 66       | L8816R.....       | 92       |
| 1721361..... | 40       | 1732305..... | 15       | 1762624..... | 27       | 5626090.....   | 67       | L8825.....        | 92       |
| 1721363..... | 40       | 1732310..... | 15       | 1762627..... | 27       | 5626191.....   | 67       | L882502.....      | 92       |
| 1721364..... | 40       | 1732315..... | 15       | 1762630..... | 27       | 56296144.....  | 67       | L8835.....        | 92       |
| 1721365..... | 40       | 1732400..... | 15       | 1762639..... | 27       | 56297145.....  | 67       | L8855.....        | 92       |
| 1721551..... | 41       | 1732403..... | 15       | 1762642..... | 27       | 5910024.....   | 91       | L8915.....        | 92       |
| 1721556..... | 41       | 1732405..... | 15       | 1762645..... | 27       | 8000SSL.....   | 93       | LL9000.....       | 92       |
| 1721561..... | 41       | 1732500..... | 15       | 1762648..... | 27       | 8000SSN.....   | 93       | LL90003.....      | 92       |
| 1721563..... | 41       | 1732503..... | 15       | 1763100..... | 27       | 88CH510.....   | 93       | UB623516.....     | 64       |
| 1721564..... | 41       | 1732505..... | 15       | 1763103..... | 27       | 88CH545.....   | 93       |                   |          |
| 1721565..... | 41       | 1732510..... | 15       | 1763106..... | 27       | 9031100.....   | 85       |                   |          |
| 1721568..... | 41       | 1734300..... | 15       | 1763109..... | 27       | 9031105.....   | 85       |                   |          |
| 1721768..... | 40       | 1734303..... | 15       | 1763121..... | 27       | 9031110.....   | 85       |                   |          |
| 1722010..... | 81       | 1734305..... | 15       | 1763124..... | 27       | 99170.....     | 95       |                   |          |
| 1722351..... | 40       | 1734400..... | 15       | 1763127..... | 27       | BP242486.....  | 71       |                   |          |
| 1722356..... | 40       | 1734403..... | 15       | 1763130..... | 27       | BP242486B..... | 71       |                   |          |
| 1722361..... | 40       | 1734405..... | 15       | 1763139..... | 27       | BP242486W..... | 71       |                   |          |
| 1722363..... | 40       | 1734500..... | 15       | 1763142..... | 27       | BP242496.....  | 71       |                   |          |
| 1722364..... | 40       | 1734503..... | 15       | 1763145..... | 27       | BP242496B..... | 71       |                   |          |
| 1722365..... | 40       | 1734505..... | 15       | 1763148..... | 27       | BP242496W..... | 71       |                   |          |

# The Buyers family of manufacturing companies

**Tracom**

**B** **Boomerang**  
RUBBER, INC.

**Romotech**  
Rotational Molding Technologies, Inc.

**P** **PROGRESSIVE**  
POWDER COATING, INC.



See pages 88-89 for Wide Open Step Boxes

[BuyersProducts.com](http://BuyersProducts.com)

**Buyers**  
PRODUCTS COMPANY

**SnowDogg**  
by Buyers

**SaltDogg**  
by Buyers

**ScoopDogg**  
by Buyers

**DumperDogg**  
by Buyers

TBLIT\_N